

KEOFITT ASEPTIC SAMPLING BAG (PAT. PEND.) | Item no. 120500, 121000 & 122000

USER MANUAL

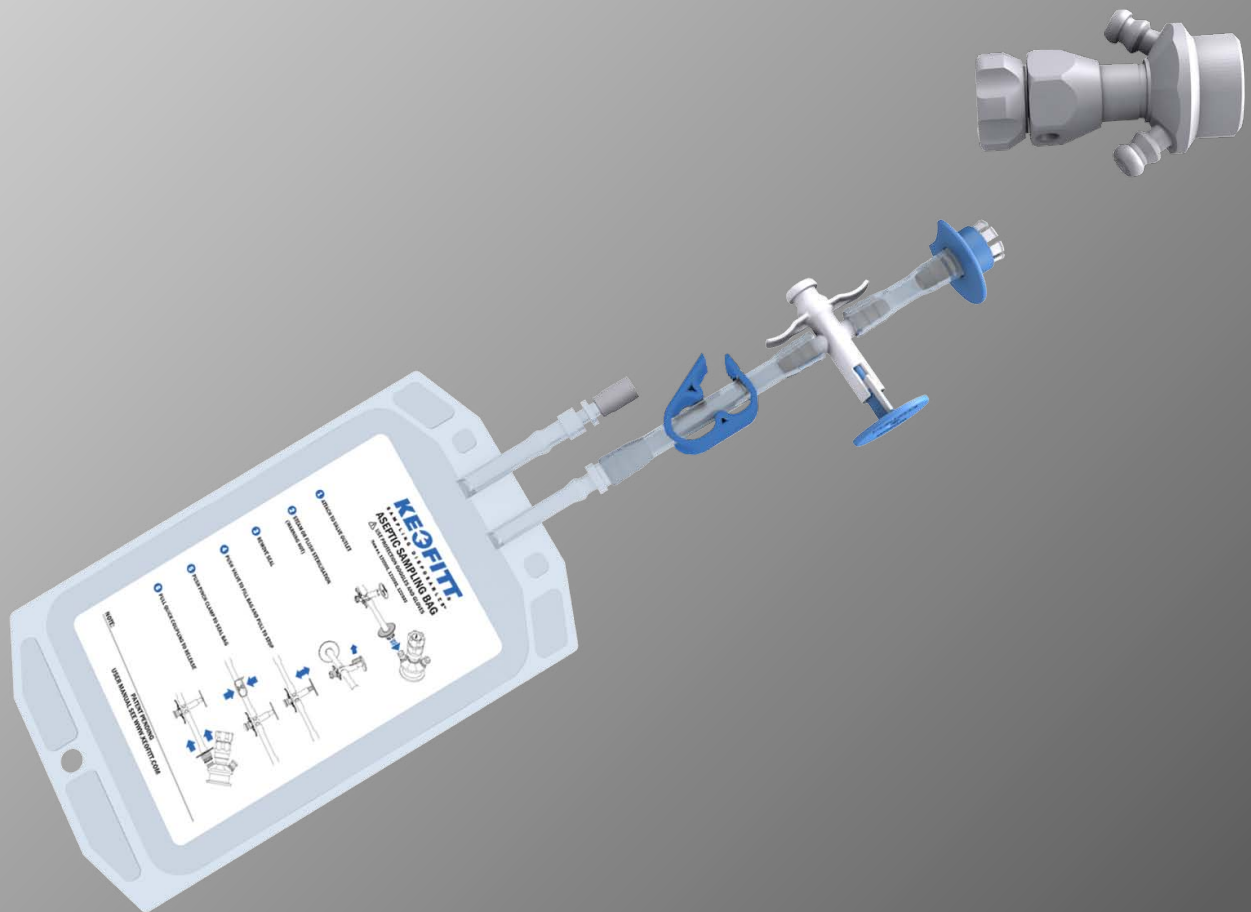

INTRODUCTION:

MANUFACTURER: Keofitt Sampling Bags ApS
Industrivænget 6-8
5700 Svendborg
Denmark

TYPE: Keofitt Aseptic Sampling Bag,
item no. 120500, 121000 &
122000

YEAR OF INTRODUCTION: 2010
YEAR OF REVISED DESIGN: -

Manufacturer retains the right to change technical specifications and the contents of this User manual without prior notice.

The English version of this Manual is the governing version and it is the only authorized version. Consequently, KEOFITT cannot be held liable for other versions including translations of this Manual.

CONTENTS

Presentation 7

Aseptic Sampling Bag function 8

Sterilization..... 8

Accessory..... 9

Part drawing Keofitt Aseptic Sampling Bag - Item 120500, 121000, 122000 10

How to Operate:..... 11

PRESENTATION

The Keofitt Aseptic Sampling Bag is a single use product. The Keofitt Aseptic Sampling Bag is a sterile, pre-irradiated product supplied in a sealed PE-bag. The product is to be removed from its sterile bag immediately before use.

The sterile condition enables the user to extract a truly representative aseptic sample from a liquid process line sampling point in a convenient way.

The Keofitt Aseptic Sampling Bag is the ultimate sampling bag solution based on Keofitt's renowned high quality and ultra hygienic sampling valve design.

The Keofitt Aseptic Sampling Bag protects the sample against airborne contamination, while extracting the sample, during transportation and storage.

The standard operating procedure involves steaming the sampling valve with the Keofitt Aseptic Sampling Bag connected, in order to sterilize the sampling valve and the connection between the sampling valve and the Keofitt Aseptic Sampling Bag.

The 3-way valve is designed to seal off sample and ensure sterility – even after valve closure. The valve sealing part is never in contact with non-sterile area.

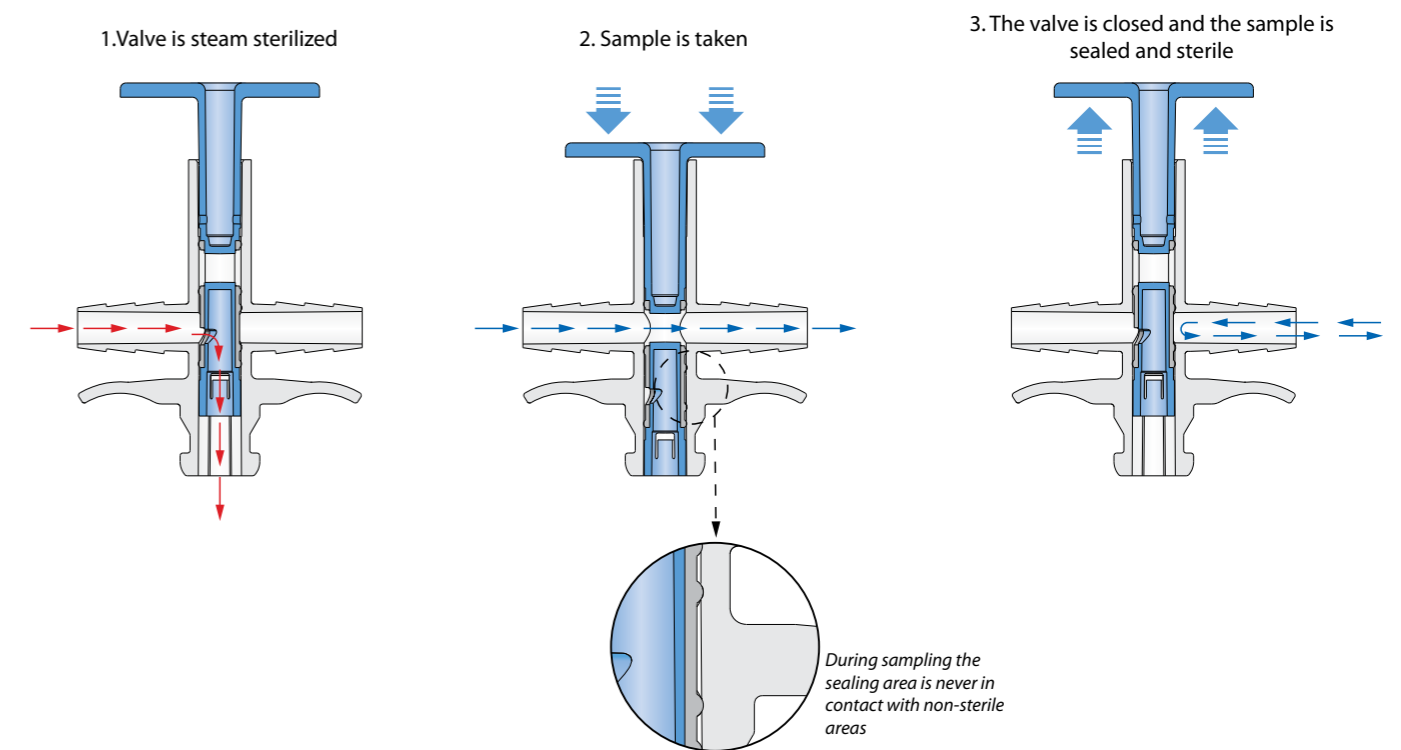

Using standard adaptors the Keofitt Aseptic Sampling Bag becomes compatible with all small and medium sized Keofitt sampling valves.

The Keofitt Aseptic Sampling Bag is used in a wide range of industries, such as breweries, dairies and the pharmaceutical and biotechnological industries.



WARNING!

- During sterilization with steam the system will become hot and emits steam, care should be taken when handling the system. Use protection goggles and gloves.

ASEPTIC SAMPLING BAG FUNCTION

The Keofitt Aseptic Sampling Bag is designed for extracting one single product sample. The design as a single use Aseptic Sampling Bag greatly reduces the risk of sample contamination occurring due to insufficient sterilization of the sample container.

The Keofitt Aseptic Sampling Bag is available in 3 different sizes – 500 ml, 1000 ml and 2000 ml. It is important to choose the adequate Aseptic Sampling Bag size in order not to overfill the bag.



WARNING!

- An overfilled or over-pressurized Aseptic Sampling Bag may result in material burst. Pay attention to sampling process at all times.

STERILIZATION

Sterilization is carried out by supplying steam through the sampling valve. Steam flushes through the hose piece and through the 3-way valve.

The Keofitt Aseptic Sampling Bag is based on the Keofitt steam sterilizable sampling valve design. According to a test carried out by DB-Lab in Denmark steam sterilizing the connection to the Aseptic Sampling Bag becomes effective after just 1 minute's supply of steam at a pressure of 2 bar[a] (1 bar[g], 121 °C).



IMPORTANT!

- Sterilization takes place with 3-way valve closed.
1. Open the steam supply 121 °C (1 bar[g]).
 2. Let the steam flow through the 3-way valve for sterilization for 1 minute.
 3. Close the steam supply.



WARNING!

- The Keofitt 3-way valve and silicone hose are designed to withstand system pressure of 1 bar[g] at 121 °C for 1 minute.

DO NOT AT ANY TIME APPLY SYSTEM PRESSURE ABOVE 1.5 BAR[g]!



WARNING!

- During steam sterilization the system becomes hot and emits steam. Care should be taken when handling the system. Use protection goggles and gloves.

ACCESSORY

Optional:

It is possible to apply a heat indicator onto the 3-way valve. The heat indicator will change colour as a function to heat vs. time. When the second dot on the heat indicator changes to black the indicator measures approx. 77 °C and the corresponding steam temperature inside has been approx. 121 °C for approx. 1 minute. The difference in time and temperature is due to slow heat transfer in the plastic valve material.

The heat indicator can be purchased separately at Keofitt A/S; Item nr. 120055

It is very important to place the heat indicator correctly – see illustration.

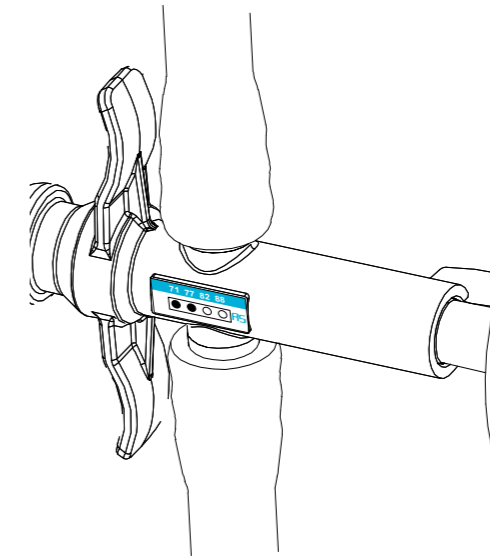

WARNING!

- The heat indicator will indicate a significant lower temperature on the outside of the valve than the actual temperature inside the valve. Beware of hot surface. Use protection gloves.



IMPORTANT!

- Using a heat indicator is convenient when assessing steam temperature, but should be used based on test and experience only!

PART DRAWING KEOFITT ASEPTIC SAMPLING BAG - ITEM 120500, 121000, 122000

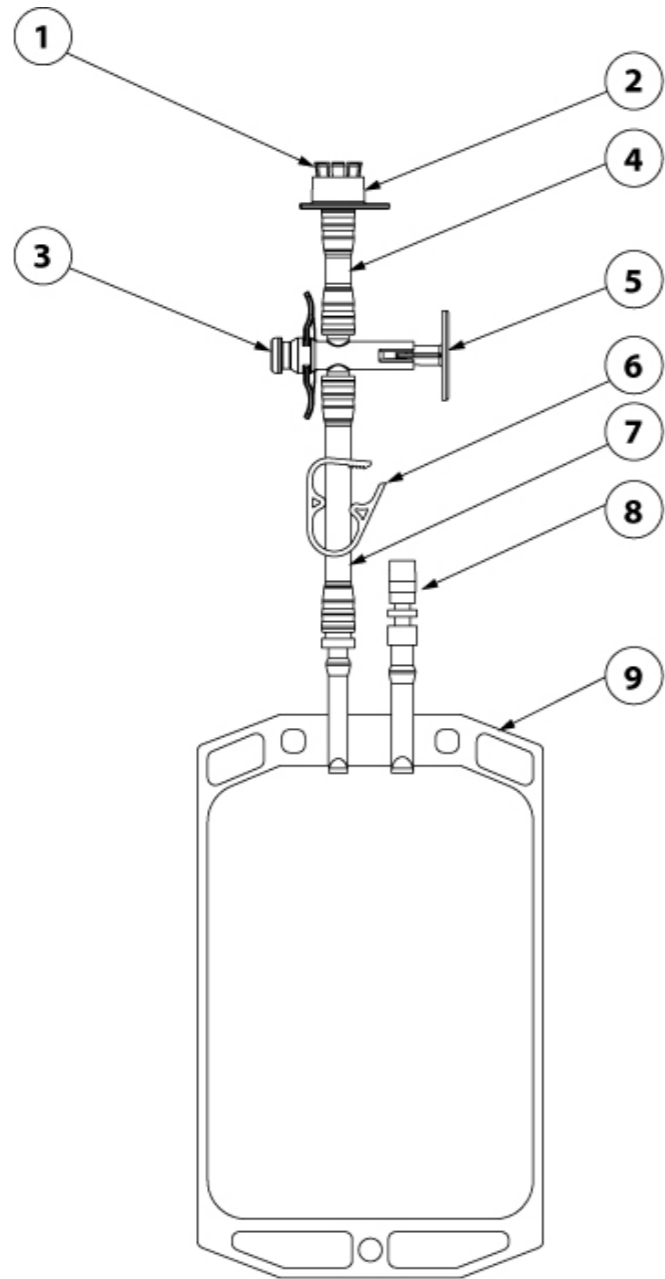

Pos.	Part Name	Material	Pos.	Part Name	Material
1	Tube fitting	PC	6	Pinch Clamp	PP
2	Quick coupling ring	PP	7	Tube	Silicone
3	3-way valve house	PC	8	Luer Lock	ABS / TPE
4	Tube	Silicone	9	Sampling Bag	PE / PA
5	3-way valve piston	PP / TPE			

HOW TO OPERATE:

Remove the Keofitt Aseptic Sampling Bag from the sealed pouch. Optional: Place heat indicator on 3-way valve.

1 ATTACH TO VALVE OUTLET

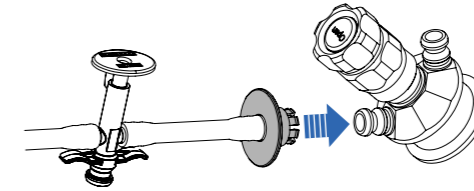

Attach the Keofitt Sterile Sampling Bag tube fitting to the sampling valve outlet sliding the blue quick coupling ring towards the valve to lock. The 3-way valve steam outlet is designed with a standard Keofitt W9 connector allowing the connection of tubing, pressure relief valve, steam trap etc.

2 STEAM OR FLUSH STERILISATION (WARNING HOT)

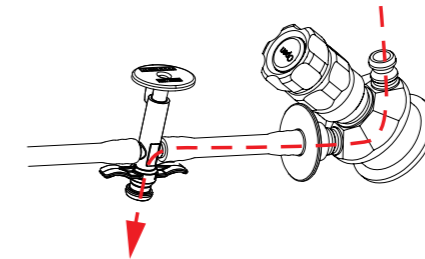

Steam supply is connected to the upper connection of the sampling valve and the assembly is sterilised for 1 minute - 1 bar[g] (121 °C).



WARNING!

- Hot. Wear goggles and gloves.

3 REMOVE SEAL

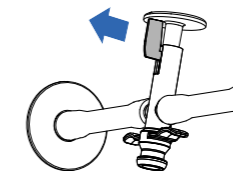

After sterilization: Break and remove the protective plastic seal preventing the valve piston from being activated unintentionally.

4 PUSH PISTON TO OPEN VALVE

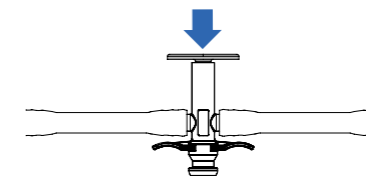

Press down the piston to open the 3-way valve.

5 OPEN SAMPLE VALVE

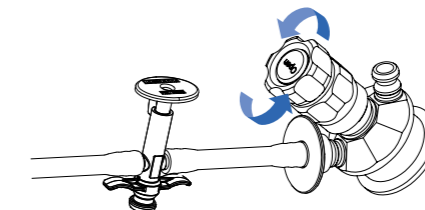

To extract the sample, the sampling valve is opened slowly.

6 TAKE SAMPLE

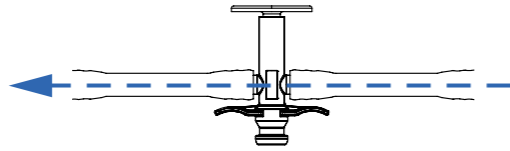

Take sample

i IMPORTANT!

- Do not remove steam connection from sampling valve until after sample has been extracted.

7 CLOSE SAMPLE VALVE

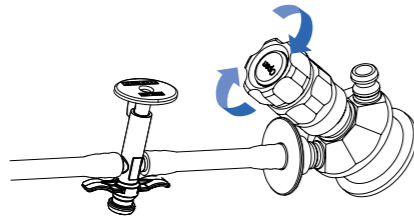

Close the sampling valve

8 PULL PISTON TO CLOSE VALVE

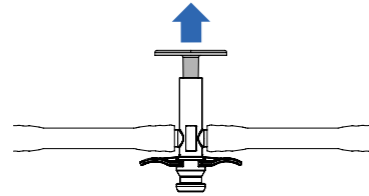

Pull the valve piston back up to close the 3-way valve.

9 PUSH PINCH CLAMP TO SEAL BAG

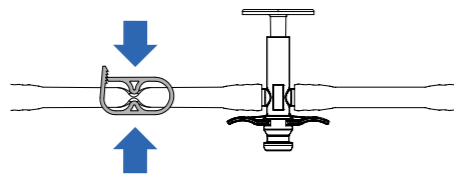

Push down the pinch clamp to make the Keofitt Aseptic Sampling Bag airtight.

10 PULL QUICK COUPLING TO RELEASE

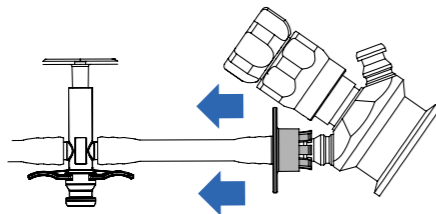

Pull back quick coupling ring and remove the Keofitt Aseptic Sampling Bag.

To extract test samples from the Keofitt Aseptic Sampling Bag, either penetrate the Luer lock Septum by a needle, connect a syringe to the male or female adaptor, or simply dismount the Luer lock to pour.

For complete set of updated data sheets and manuals for Keofitt products please refer to our web page
www.keofitt.dk

