

W9™ SAMPLING VALVE
INGOLD SAMPLING VALVE
User Manual

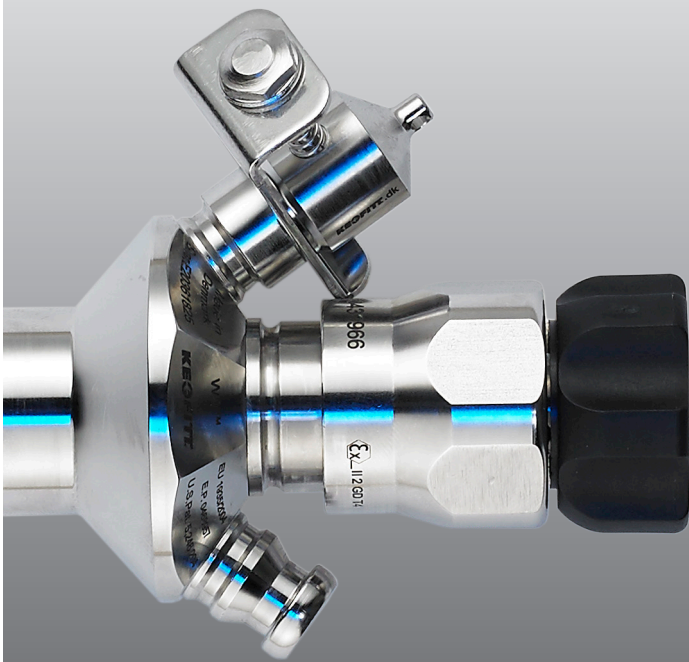

DOCUMENT VERSION LOG

The table below lists previous versions of this User Manual and states the major changes between versions.

This version list is introduced in November 2015.

Version #	Version date	Major changes from previous versions
1	September 2015	Latest version without version log
2	11 th November 2015	Various amendments to the text in 5, 5.1, 5.2, 6.3, 6.4, A new chapter 6.7 Flow. Added Warning in 13.2. New chapter 13.3. New illustration in 14. Updated data sheets in 16.x.
3	September 2017	Chapter 3 rewritten and extended. Rubber cap and steel cap instructions added to chapter 5. Expanded temperature ranges in chapter 6.4. Chapter 13 MAINTENACE extended and more detailed. A new chapter 14 FAILURE MODES added.
4	November 2017	More valve body configurations. More accessories. PTFE upgrade kits discontinued (chapt. 15). Clarifying text in various places.
5	April 2018	INGOLD version added. Type N head with adjustable head added. Specific valve opening instructions added to chapter 5.4. EHEDG specifications. 3A certificate included.

INTRODUCTION:

MANUFACTURER: Keofitt A/S
Kullinggade 31 B+E
5700 Svendborg, Denmark

TYPE: W9™ SAMPLING VALVE

PATENTS: U.S. PAT. 5,246,204 • E.P. 0468957

YEAR OF INTRODUCTION: 1998

YEAR OF REVISED DESIGN: 2014

MANUAL LAST UPDATED: April 2018

The English version of this Manual is the governing version and it is the only authorized version. Consequently, KEOFITT cannot be held liable for other versions including translations of this Manual.

CONTENTS

1. PRESENTATION	7
1.1 Definition of terms	7
1.2 Quick start	9
2. CLEANING – DISINFECTION – STERILISATION	10
2.1 Clean-In-Place (CIP)	10
2.2 Disinfection	10
3. VALVE DESIGN AND FUNCTIONING	12
3.1 Valve body configurations.....	12
3.2 Valve head configurations.....	13
3.3 Valve surfaces and roughness certificate	13
3.4 Micro Port option	13
3.5 Rubber caps and steel caps.....	13
3.6 Sampling coil.....	14
3.7 Membranes.....	14
3.8 Parts and Accessories	15
3.9 Pressure and vacuum	15
3.10 Valve cleaning / disinfection / sterilisation.....	16
4. EVERYDAY USE OF THE VALVE	18
4.1 Batch change cleaning.....	18
4.2 Chemical cleaning, CIP	18
4.3 Chemical Disinfection	19
4.4 Steam sterilisation	19
4.5 Sampling	19
5. VALVE OPERATIONS	20
5.1 Chemical CIP	21
5.2 Chemical disinfection	22
5.3 Steam sterilisation	24
5.4 Sampling	25
6. TECHNICAL DATA	29
6.1 Material	29
6.2 Certificate.....	29
6.3 Pressure (max.)	29
6.4 Temperature.....	29
6.5 Surface finish.....	30
6.6 Viscosity.....	30
6.7 Flow	30
7. VALVE BODIES	32
8. VALVE HEADS	34
10.MOUNTING INSTRUCTIONS	38
10.1 Location.....	38
10.2 Before welding	38

11. WELDING INSTRUCTIONS.....	39
11.1 Welding method.....	39
11.2 Guideline welding values	39
12. BLOCK DIAGRAMS	40
12.1 Keofitt valve type T (tank)	40
12.2 Keofitt valve type P (pipe)	40
12.3 Keofitt valve type P (pipe connection vertical) Inline	41
12.4 Keofitt valve type clamp connection	41
12.5 Keofitt valve type Varivent®	42
12.6 Keofitt valve type thread	42
13. MAINTENANCE	43
13.1 Maintainance	43
13.2 Spare parts list	43
13.3 Disassembly and assembly of valve body and head.....	44
13.4 Replacing a rubber membrane	45
13.5 Replacing a PTFE membrane	46
13.6 Regrease the head spindle	47
14. FAILURE MODES	48
14.1 Broken membrane tip:.....	48
14.2 Broken membrane side:.....	48
14.3 Cleaning the valve after a failure:.....	48
15. CHANGE FROM SILICONE/EPDM/FFKM TO PTFE MEMBRANE	49
16. MEMBRANES.....	50
16.1 Silicone membrane - art. no. 600051	50
16.2 Silicone membrane for Micro Port - art. no. 600251.....	51
16.3 EPDM membrane - art. no. 600052.....	52
16.4 EPDM membrane for Micro Port - art. no. 600252	53
16.5 FFKM membrane - art. no. 600053	54
16.6 PTFE membrane - art. no. 850055.....	55
16.7 Silicone membrane - art. no. 310051	56
16.8 EPDM membrane - art. no. 310052.....	57
16.9 PTFE membrane - art. no. 310055.....	58
16.10 Silicone membrane - art. no. 320051	59
16.11 EPDM membrane - art. no. 320052.....	60
16.12 PTFE membrane - art. no. 320055.....	61

1. PRESENTATION

This manual describes the Keofitt W9™ sampling valve in all its variants and configurations.

The manual also covers the special variant INGOLD, which in terms of functionality has a lot in common with the W9. The issues which are specific to the INGOLD valve are described in designated sections of chapter 3.1 "Valve body configurations" and chapter 3.2 "Valve head configurations".

Any general description of the W9 valve will also in principle apply to the INGOLD valve unless stated otherwise.

The Keofitt W9™ sampling valve can be readily cleaned and disinfected/sterilised as it meets both hygienic and process design requirements. Effective cleaning and disinfection/sterilisation of the sampling valve can be carried out between random samples independently of the course of the production process without compromising the same. The coaxial design and the smooth electro polished valve interior ensure absolute cleanability and sterilisability.

Keofitt works since many years with a number of associations promoting good hygienic standards such as 3-A and EHEDG.

The American 3-A Sanitary Standard is normative for the component's ease of cleaning and sterilisation and ensures optimum conditions for food products, which comes in contact with the component in question.

All Keofitt valves fulfill the hygienic design criteria laid out in the EHEDG Guideline Doc. 8 "HYGIENIC EQUIPMENT DESIGN CRITERIA" from 2004.

Various test reports and certificates are to be found on the Keofitt website www.keofitt.dk.

Keofitt valves are used in a wide range of processing industries, such as breweries, dairies, juice/soft drinks and the biotechnological and pharmaceutical industries, which all have different requirements and demands.

1.1 Definition of terms

In order to ease the reading of this manual and to avoid any misunderstanding, please refer to the definition of terms in the table below:

TERM	DEFINITION
3-A Sanitary Standard	3-A SSI is an independent, not-for-profit US corporation dedicated to advancing hygienic equipment design for the food, beverage and pharmaceutical industries.
Acids	An acid is a chemical substance whose aqueous solutions are characterized by a sour taste and the ability to react with bases and certain metals (like calcium) to form salts. Aqueous solutions of acids have a pH of less than 7. A lower pH means a higher acidity, and thus a higher concentration of positive hydrogen ions in the solution. Removes limestone and most mineral deposits.
Alkali	Alkalis are all bases, which form hydroxide ions (OH-) when dissolved in water. The terms "base" and "alkali" are often used interchangeably. Alkalis have a pH value above 7. Alkalis dissolves fat and oil, destroys protein and attacks light metal.
Aseptic sampling	The process of withdrawing a sample from the production equipment through a closed circuit, which has been sterilised and kept sterile with no exposure to the surroundings during the sampling process.

Bioload	See Microbial load.
Bioburden	See Microbial load.
Chemical Sterilant	A few disinfectants will kill spores with prolonged exposure times (3–12 hours); these are called chemical sterilants.
Chlorine	Chlorine is a chemical element with symbol Cl and atomic number 17. It belongs to the halogen group together with for instance iodine. It is a strong oxidizing agent and reacts with many substances. These properties make chlorine compounds efficient disinfectants.
CIP	Abbreviation of Clean-In-Place. The process of cleaning a process component (like a sampling valve) without removing it from the production line.
Cleaning	Removal, usually with detergent and water or enzyme cleaner and water, of adherent visible soil on a surface.
Complexing agent	A substance capable of forming a complex compound with another material in solution. Improves the cleaning properties of a detergent.
Contact time	The time span during which the item is in contact with the detergent or the disinfectant.
Enzymes	Molecules, which are added to cleaning agents to ease the removal of specific organic material. Assures same cleaning effect at a lower temperature.
Disinfectant	Usually a chemical agent that destroys harmful microorganisms but might not kill bacterial spores.
Disinfection	Thermal or chemical destruction of microorganisms. Disinfection is less lethal than sterilisation, because it destroys most recognised microorganisms but not necessarily all microbial forms (e.g. bacterial spores).
Detergent	A cleaning agent that has no antimicrobial effect, but in diluted solutions good cleaning properties.
EHEDG	Abbreviation for the European Hygiene Engineering and Design Group. EHEDG is a consortium of equipment manufacturers, food industries, research institutes as well as public health authorities promoting safe food by improving hygienic engineering and design in all aspects of food manufacture.
Electro polishing	Electro polishing is an electrochemical process by which the high points within the microscopic surface texture are removed and the corners rounded. This results in Reduced Product Adhesion, Ease of Cleaning and Improved Corrosion Resistance.
Exposure time	Period in a sterilisation/disinfection process during which the item is exposed to the sterilant/disinfectant at the specific sterilisation/disinfection parameters.
Flow path	The path the sample flows from the tank or process equipment to the sample recipient.
Germicidal	The property of an agent to destroy microorganisms.
Microbial load	The number and types of viable microorganisms with which an item is contaminated; also called bioload or bioburden.
Microorganisms	Animals or plants of microscopic size. As used in food and pharmaceutical industries, generally refers to bacteria, fungi, viruses and bacterial spores.
Peracetic acid	A commonly used disinfectant, which is efficient at low temperature and short contact time. Relatively harmless as it decomposes into carbon dioxide (CO ₂) and water (H ₂ O).

Process media	The product in the process equipment and the product from which a sample is taken.
Representative sample	A sample which when it reaches the laboratory is still identical to the process media. A sample which is in no way contaminated or altered during neither the sampling process nor the transport to the laboratory.
Sanitization	The application of a chemical agent that reduces the number of bacterial contaminants to a safe level as judged by the public health authorities. The official sanitizer protocol indicates that 99.999% of the specific test bacteria be killed in 30 seconds under the conditions of the test.
SIP	Abbreviation for Sterilise-In-Place. The process of rendering a process component (like a sampling valve) sterile without removing it from the production line.
Spores	Relatively water-poor resting cells surrounded by an impervious cell wall, which makes them relatively resistant to disinfectants and sterilants. They are dangerous as they can survive in adverse conditions and re-emerge as live bacteria at a later stage.
Sporicidal	The property of an agent that kills spores.
Steaming	The process of using saturated steam under pressure as the sterilising agent.
Sterile	State of being free from all living microorganisms. In practice, usually described as a probability function, e.g., as the probability of any microorganism surviving sterilisation being one in one million.
Sterilant	A few disinfectants will kill spores with prolonged exposure times (3–12 hours); these are called chemical sterilants.
Sterilisation	Validated process used to render an item free of all forms of viable microorganisms. In a sterilisation process, the presence of microorganisms is expressed in terms of probability. Although this probability can be reduced to a very low number, it can never be reduced to zero.
Sterility Assurance Level	The probability of a viable microorganism being present on an item after sterilisation. Usually expressed as 10^{-n} ; a SAL of 10^{-6} means <1/1 million chance that a single viable microorganism is present on a sterilised item.
Tensides	A tenside is a surfactant that reduces the surface tension of water and assures a faster and better contact between the detergent and the soil.

1.2 Quick start

The table below gives you an overview of the relevant chapters to read depending on the operations you want to perform to obtain the required hygienic level.

Required hygienic level	4.1 Pre-production treatment	4.2 Chemical cleaning CIP	4.3 Chemical disinfection	4.4 Steaming	5.1 Chemical CIP	5.2 Chemical disinfection	5.3 Steam sterilisation	5.4 Sampling
Cleaning	✓	✓			✓			✓
Disinfection	✓		✓			✓		✓
Sterilisation	✓			✓			✓	✓

2. CLEANING – DISINFECTION – STERILISATION

This chapter gives introduction to the concepts of cleaning, disinfecting and sterilising process equipment in general, but with focus on sampling valves.

2.1 Clean-In-Place (CIP)

Thorough cleaning of the valve is a prerequisite for proper disinfection or sterilisation. Cleaning of the valve is the removal of any visible residual product, it be organic or inorganic. It may be done using either steam (continuous steam will eventually lead to sterility; SIP = Sterilise-In-Place) or a suitable liquid detergent.

Cleaning is the removal of adhering soil from the environment and from the previous sample (to the extent it has not been removed by the recommended post-sample cleaning). Cleaning is usually performed by flushing with water followed by a thorough washing with an appropriate detergent and finished off with a thorough rinsing with water.

Depending on the actual process media the proper detergent must be determined in cooperation with your usual supplier of detergents. The company Novadan ApS, Kolding, Denmark - www.novadan.dk, has supplied the generic table below for your convenience.

What to clean for	Generic cleaning agents	Comments
Fat	Alkali and Tensides	Heat will facilitate the cleaning process as the fat melts
Protein	Alkali, Acids, Tensides and Chlorine	Coagulation and burning when heated, which makes the product hard to remove.
Sugar, Salt	Water is usually sufficient as the product is water soluble	Sugar caramelises when heated, turning into a hard sticky substance, which is difficult to remove
Minerals	Acids, Complexing agent	Often seen as lime scale
Biofilm	Alkali and Chlorine, Peracetic acid, possibly Enzymes	Biofilm is an accumulated mass of microorganisms that is tightly adhered to a surface and cannot be easily removed.
Starch	Alkali and Chlorine	

2.2 Disinfection

Although CIP removes all visible residues of the process media the valve surfaces will still be contaminated on a microscopic level. Depending on your actual process media it will be necessary to carry out a disinfection operation in order to a) reduce the microbial load to an acceptable level (also referred to as Sanitization) or b) destroy critical microorganisms, but not necessarily all microbial forms (e.g. bacterial spores).

The disinfection process may be carried out in one of two ways and to different levels of disinfection depending on a) the initial microbial load distribution, b) the required hygienic level and c) the type, exposure time and concentration of the chemicals used (if using a chemical disinfectant):

- By steaming (in a continued process after steam cleaning)
- By applying one or more suitable liquid chemical disinfectants

There are a number of chemical disinfectants. It is important to choose the right one, the right concentration and contact time and the right method for your current application. Your usual supplier of chemical disinfectants can support you in choosing the right disinfectant for your process media and the specific group of microorganisms you are aiming at.

The company Novadan ApS, Kolding, Denmark has supplied the table below, as a preliminary indication of which type of disinfectant to use:

Disinfectant	Halogenes (Clorine)	Peroxides (hydrogenperoxid & peracetic acid)	Alcohol (70%)
Microbes to inactivate			
Gram-neg bacteria Salmonella Campylobacter E. Coli and others...			
Gram-pos bacteria Listeria Bacillus cereus Clostridium and others...			
Bacteria spores Bacillus cereus and others...			
Bacteriophage			
Yeast			
Fungi			
Virus			

Legend:

Efficient	Limited effect	Little/No effect
-----------	----------------	------------------

NOTE! The final choice of detergent, disinfectant and method lies with the user, supported by the supplier of the CIP fluids and disinfectants, as it is very much dependant on individual concerns and circumstances.

2.3 Sterilisation

Sterilisation is a high-level disinfection designed to render the valve free of all forms of viable microorganisms (incl. bacterial spores) to a high level of certainty; the so-called Sterility Assurance Level or SAL. A SAL value of 10^{-6} means that the probability (or risk) of a single viable microorganism being present on the valve interior afterwards is only 1 in 1,000,000 which is a generally accepted level for calling an item sterile. Although the probability can be reduced to a very low number, it can never be reduced to zero.

Sterility may in practise only be obtained by steaming. Disinfectants exist that in high concentrations and for a prolonged exposure time will be able to inactivate all forms of microorganisms and render the valve interior sterile with a high probability; these disinfectants are called chemical sterilants. However, the application of chemical sterilants is most often problematic due to a) a required high concentration, which causes an operator hazard and b) the several hours of exposure time.

NOTE! Furthermore, sterilisation with a chemical sterilant may not convey the same sterility assurance as sterilisation with steam, because the germicidal and sporicidal kinetics are much less investigated and documented for chemical sterilants compared to steam.

3. VALVE DESIGN AND FUNCTIONING

The Keofitt sampling valve is conceived to extract representative samples from a production process at regular intervals during a batch without compromising the ongoing process. The valve is therefore designed such that effective cleaning, disinfection/sterilisation and sampling can be carried out regularly without disturbing the production process.

Throughout this chapter "W9" designates all variants and configurations except those from the INGOLD family, which are all designated "INGOLD".

3.1 Valve body configurations

W9 bodies:

Valve bodies may be welded to the process equipment or connected by means of one of the standard connector systems.

Welding configurations encompass the following options:

- Tank welding, $\varnothing 28$ mm
- Pipe welding, 1"
- Pipe welding, NW25
- In-line vertical
- In-line horizontal

Connector configurations encompass the following options:

- Varivent, $\varnothing 50$ mm
- Varivent, $\varnothing 68$ mm
- Clamp $\frac{1}{2}$ " Mini-Clamp or Mini Tri-Clamp (always use a gasket; not included in valve body delivery)
- Clamp 1"; NA-connect, DIN/ASME (always use a gasket; not included in valve body delivery)
- Clamp 2"; NA-connect, DIN/ASME (always use a gasket; not included in valve body delivery)
- Clamp 3"; NA-connect, DIN/ASME (always use a gasket; not included in the valve body delivery)
- Thread
- DIN 11851

The inlet and outlet ports are available in the following configurations:

- Hose Piece (Keofitt Quick Coupling)
- Mini Tri-clamp (always use a gasket; not included in valve body delivery)
- Thread M16x1.5
- Welding ends (to weld steel tubing on)

All welding/connector options are available with Hose Piece ports. For the other port configurations only some combinations are standard; but all non-standard combinations are likely to be available "On request".

All valve bodies with their various ports are machined in one piece of steel, thus avoiding all crevices and fissures from screwed or welded parts.

For further information please consult www.keofitt.dk.

INGOLD bodies:

All INGOLD bodies are mounted to the process equipment through a 25 mm INGOLD socket having a length of 40 mm. or 52 mm.

Connector configurations encompass the following options:

- For 40 mm. socket
- For 52 mm. socket

The inlet and outlet ports are available in the following configurations:

- Mini Tri-clamp, long, 52 mm, 60 degrees apart
- Mini Tri-clamp, short, 20 mm, 90 degrees apart

All valve bodies with their various ports are machined in one piece of steel, thus avoiding all crevices and fissures from screwed or welded parts.

For further information please consult www.keofitt.dk.

3.2 Valve head configurations

W9 heads:

Valve heads come in the following configurations:

- Turn knob (type H)
- Turn knob with MicroPort option (type H)
- Key ring (type K)
- Key ring with MicroPort option (type K)
- Lever handle (type Q)
- Pneumatic (type N)
- Pneumatic with adjustable stroke (type N)
- No spring, turn knob, 0-12 bar (type B) *

*) type B closes mechanically like an ordinary water tap, whereas a spring provides a constant closing force on all other valve heads

All configurations may be delivered with EPDM or Silicone membranes.

All configurations except the MicroPort options may be delivered with PTFE or FFKM membranes.

INGOLD heads:

Valve heads come in the following configurations:

- Turn knob (type H)
- Lever handle (type Q)
- Pneumatic (type N)
- Pneumatic with adjustable stroke (type N) – On request only

All configurations may be delivered with EPDM, Silicone or PTFE membranes.

3.3 Valve surfaces and roughness certificate

All Keofitt valves are electro polished internally using a proprietary technique and each valve has its individual certificate (Test Report) stating the results of 4 test measurements of the surface roughness in each of the 2 ports, in the valve chamber and on the outer body surface with product contact.

For obvious reasons, the surface properties of the internal product contact areas of a sampling valve is much more important from a hygiene perspective than any shiny outside surface appearance. Therefore, Keofitt has developed a unique electrode configuration to assure during manufacturing that the internal surfaces in particular are properly electro polished.

3.4 Micro Port option

The W9 valve head is available in a version (part no. 600048), where it is possible to take a sample using a long hypodermic needle (part no. 900022).

The valve head is foreseen with a turn knob (type H) and is available with either a silicone membrane or an EPDM membrane.

In order to take a sample, remove the plug in the turn knob and introduce the needle through the valve head until it penetrates the membrane and enters into the process. The membrane is reinforced at the tip in order to obtain an auto-sealing effect after the needle has been removed. Nevertheless, the number of samples taken using a needle is very limited (1-5 samples) and depends on the actual operating conditions (pressure, temperature, viscosity etc.)

If a sample is taken using a needle it is highly recommended to replace the membrane before launching the next production batch.

For further information please consult www.keofitt.dk.

3.5 Rubber caps and steel caps

The hose piece version of the valve bodies all come with a set of rubber caps (EPDM) connected to the body by two small chains.

The purpose of the caps is to protect the valve chamber from the environment between sampling. Furthermore, a cap on the top port forces product to only flow out through the lower port during sampling; in particular in case of high flow/pressure.

Steel caps (part no. 800061) may be used instead of rubber caps and will provide a stronger mechanical fixation to the hose piece and thus be operational under higher pressure and temperature. Furthermore, the steel plugs may be autoclaved.

For further information please consult www.keofitt.dk.

3.6 Sampling coil

When sampling beer, the rapid pressure drop from inside the tank (CO₂ pressure of 2-3 bar) to the open pressure less sample recipient causes excessive foaming, even when opening the valve very slowly and very little. This phenomenon may be alleviated connecting a sampling coil (part no. 800058) between the sampling valve and the sample recipient. A sampling coil provides a slower pressure drop as the sample flows through the full length of the coil, approx. 1 m.

For further information please consult www.keofitt.dk.

3.7 Membranes

All valve heads may be delivered with any of the 4 materials: Silicone, EPDM, PTFE and FFKM.

The only exceptions are the MicroPort Valve head, for which membranes are only available in Silicone and EPDM and the INGOLD valve heads for which no FFKM membrane is available.

They all have different properties and different resistance to various chemical substances, as seen in the table below.

Resistance to -	EPDM	Silicone	PTFE (Teflon)	FFKM
- weather and Ozone	✓✓✓	✓✓✓	✓✓✓	✓✓✓
- hydrolysis (water and steam)	✓✓✓	✓✓	✓✓✓	✓✓✓
- to acids and bases	✓✓	✓	✓✓✓	✓✓✓
- mineral oil and gas	✗	✓	✓✓✓	✓✓✓
✗=not suitable ✓=less suitable ✓=Suitable ✓✓=Very Good ✓✓✓=Excellent				

Put in words the properties can also be described like this:

- The Silicone membrane has the advantage that it in general can withstand high temperatures, but it cannot tolerate moisture condensation resulting from steam sterilisation
- The EPDM membrane is better able to cope with the condensation in the steam and at the same time it can be used with a majority of CIP fluids and disinfectants in normal concentrations
- The PTFE membrane resists all CIP fluids and disinfectants except highly oxidising acids in high concentrations
- The FFKM covers the highest temperature range and has excellent chemical resistance to virtually any chemical compound

Membranes in rubber materials like EPDM, Silicone and FFKM are fully interchangeable (except for the MicroPort version). This means that you may change from for instance Silicone to EPDM, if required. However, valve heads with PTFE membranes are designed differently from the others. As PTFE is a stiff material with no elastic properties, it cannot be stretched. Therefore, it is made with a bellow to allow for

the valve movement.

If you would want to upgrade from Silicone/EPDM to PTFE, it is necessary to contact your local Keofitt dealer or Keofitt directly.

NOTE! The membrane functions as a dynamic seal in the valve seat as well as a hygienic static sealing against the valve head.

3.8 Parts and Accessories

Keofitt provide a huge number of spare parts and accessories to the entire range of sampling valves. These include accessories like:

- Barbed fittings and tube welding fittings for tubes and hoses
- Adaptors between Tri-clamp, Mini Tri-clamp and Hose Piece (Quick Coupling)
- Spike Bag holders and Spikes
- Fitted PTFE tubing for Quick Coupling and Tri-clamp
- Any length of PTFE tube
- Proximity sensors
- Clamps for Tri-clamp connections
- Hypodermic needles
- Click-on steamer
- Circulator
- Aseptic Sampling Bags
- Sampling bottle systems

and spare parts like:

- O-rings and gaskets
- Chains and bushings
- Handles and Tommy Bars
- Set screws
- Membranes

3.9 Pressure and vacuum

Pressure ratings:

All valves with the exception of valves with valve head type B features a spring to provide the closing force against the valve seat. The spring is dimensioned such that all valves must pass a pressure test up to 10 bar. At some tank pressure above 10 bar the spring will give way and the valve will leak.

A nominal max. constant pressure of 6 bar allow sufficient tolerance to cater for the most common pressure peaks in a process line.

In the type B valve head the closing pressure is exerted by turning the knob firmly by hand; it closes like an ordinary water tap. In this way, this valve may be used in equipment with a nominal max. pressure of 12 bar.

Vacuum ratings:

On installations where vacuum may occur temporarily, rubber membranes (EPDM, FFKM, Silicone) are at risk of being sucked hard into the valve seat, whereby the valve might not open properly. However, the additional (closing) force from the vacuum (corresponding to max. -1 bar(g) or 0 bar(abs)) is rather small (10%) compared the force exerted by the spring (corresponding to at least 10 bar(g)), so there is no risk of damaging the membrane as long as the vacuum is only present when the valve is closed.

Besides, attempting to open a sampling valve under vacuum makes no sense, since nothing will flow out, so the incident is rather improbable.

Rubber membranes will seal perfectly well against vacuum, when the valve is kept closed.

WARNING: When opening the valve while the process side is under vacuum there is a risk that the

membrane may be sucked past the valve seat and into the valve opening, which could cause the membrane to be damaged.

On installations where vacuum will occur, PTFE membranes don't have the risk of being sucked into the valve seat, but as it is a harder and less flexible material a complete tightness against the ambient air may not be secured.

3.10 Valve cleaning / disinfection / sterilisation

The table below describes the two fundamentally different ways of preparing the valve for sampling, 1) Chemical cleaning/disinfection and 2) Steaming:

	Method	Description	Pros & Cons
Chemical	Chemical cleaning	Liquid detergents are used to clean the valve. CIP = Clean-In-Place	This process is adopted where steam is not available or where the product cannot withstand the exposure to heat. Involves several stages with flushing, cleaning and rinsing between batches.
	Chemical disinfection	A disinfection process using an appropriate chemical liquid disinfectant usually follows the cleaning process. The valve interior is wetted, soaked or flushed with an appropriate disinfectant.	It adds 2 more stages to the CIP: application of disinfectant and final rinse. Involves handling of potentially hazardous chemicals.
Thermal	Sterilisation	Steam is supplied for 1 minute just before and immediately after sampling.	Steaming does flushing, cleaning, rinsing and sterilisation in one operation. Steaming may be less suitable with very heat sensitive products. Steaming entails the risk of burns.

Flushing with water followed by the supply of a chemical detergent through the upper of the valve's two hose pieces results in cleaning the valve (CIP). It is the perfect, hygienic design and surface finish of the inner part of the valve, which enables easy, efficient and reliable cleaning in a closed state of the valve. Supplying steam through the upper of the valve's two hose pieces results in cleaning and sterilisation. It is the perfect, hygienic design and surface finish of the inner part of the valve, which enables sterilisation in a closed state. According to an EHEDG based test conducted by the Biotechnological Institute in Denmark, the valve is sterile after just 1 minute's supply of steam at a pressure of 1 bar(g), 121 °C. Steaming is therefore an SIP process (Sterilise-In-Place).

Following CIP or SIP, but prior to sampling, a sterile plug of rubber or stainless steel is fitted to the top hose piece. When the valve is opened the process product will run out of the lower hose piece.



WARNING

- During sterilisation with steam the valve will become hot and care should thus be taken when operating the valve
- The valve is designed for use in working conditions of up to 6 bar(g) pressure and temperatures of up to 121 C. It is therefore important to be aware that the rubber plug (designed for max. 3 bar(g)) or the steel plug (designed for max. 10 bar(g)) may be forced out at high speed, if not seated properly
- When steaming always use dry saturated steam without condensation at max. 1 bar(g). At higher pressure the membrane may be damaged/split
- Always remember to use safety goggles when steaming, CIPping, taking samples and all other operations of the sampling valve

4. EVERYDAY USE OF THE VALVE

This chapter gives an introduction to how the sampling valve works in different operating conditions, such as the cleaning of the entire production line before starting a new batch (chapter 4.1) and the cleaning of the valve between each sample during the batch production (chapters 4.2-4.4)

All illustrations in the this chapter show a W9 valve head with a turn knob (type H), but the instructions also apply to the INGOLD variants and to the W9 valve heads with a key (type K), a handle (type Q) or a pneumatic actuator (type N). Please see chapter 3.2 for a description of the different valve head configurations.

For specific operator instructions please refer to the chapter 5. “VALVE OPERATIONS”.

4.1 Batch change cleaning

Before every new production batch the sampling valve is cleaned and disinfected/sterilised together with the tank or vessel or the entire production line.

Make sure the valve is in its OPEN position during the initial line CIP to allow cleaning of the valve seat and the membrane contact surface.

Also allow CIP fluid, disinfectant or steam to flow through the inlet and outlet hose pieces. If the valve is fitted to a tank, which is spray cleaned there will be insufficient flow of CIP liquid through the valve. Therefore connect CIP hoses to the two ports for CIP fluids to flow through the valve into the tank (see illustration below).

If the valve is fitted to a pipe there will usually be enough pressure and flow during the CIP process for the CIP fluid to flow through the valve.

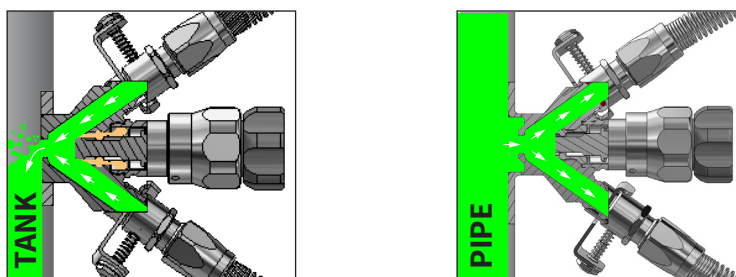

Remember to close the valve after the final rinse and prior to starting up the next production batch.

4.2 Chemical cleaning, CIP

During production and prior to sampling, cleaning takes place with the valve closed and involves the following stages:

- 1. Pre-rinse**
Flushing with water to mechanically remove product residues
- 2. Clean**
Applying a detergent to remove remaining visible product residues
- 3. Final rinse**
Rinse with clean water to remove all traces of detergents

Usually this procedure is followed by disinfection (see below), but for some application CIP might be sufficient. It depends on your (microbiological) requirements, the detergents applied and the process media to clean for. Consult your supplier of CIP fluids.

In some cases where the process media is for instance water, CIP might not even be necessary and you may go directly to disinfection.

4.3 Chemical Disinfection

Disinfection takes place with the valve closed and involves the following stages of which the first 3 are identical to CIP:

- 1. Pre-rinse**
Flushing with water to mechanically remove product residues
- 2. Clean**
Applying a detergent to remove remaining visible product residues
- 3. Intermediate rinse**
Rinse with clean water to remove all traces of detergents
- 4. Disinfection**
Apply an appropriate disinfectant targeting one or more or all microorganisms
- 5. Final rinse**
Rinse with cleaned water to remove all traces of the disinfectant

4.4 Steam sterilisation

Steaming has the advantage that it does flushing, cleaning and sterilisation in one operation. However the heat from the steam will cause sugary substances to caramelize and substances containing protein to coagulate and burn; see chapter 2.1. In this case flushing with an appropriate fluid must precede post-sampling steaming.

If steaming is the preferred procedure, but no steam is installed near the sampling point, an option is to use a portable steam generator. Keofitt supplies an adapter for a Kärcher steam generator as well as other mobile steam supply systems. The steaming process with a Keofitt sampling valve has been validated to obtain sterility after 1 minute of steaming at 121° C (1 bar(g)). Documentation is available at the Keofitt Online Service Center on www.keofitt.dk.

4.5 Sampling

Once the cleaning/disinfecting/sterilising is accomplished taking a sample is done by opening the valve and closing it again once the required sample volume is obtained.

For detailed operator instructions see chapter 5.4.

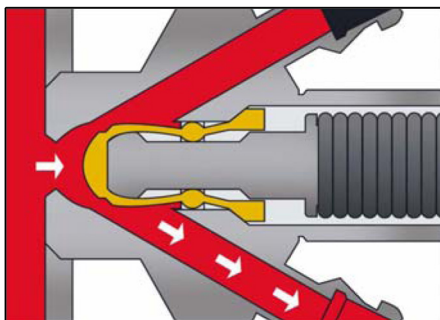

5. VALVE OPERATIONS

This chapter provides clear instructions on how to operate the sampling valve in different situations. Before sampling the valve must be cleaned followed by disinfection or sterilisation, depending on your requirements.

NOTE! For the initial cleaning before a new batch please refer to chapter 4.1 “Batch change cleaning” and integrate the valve cleaning in your standard CIP procedure.

Valve bodies with hose piece connectors (Quick Couplings) are supplied with rubber caps (part no. 600062) to protect the inlet/outlet ports and the valve chamber from being contaminated by the environment between samples.

A rubber cap placed at the inlet port (top port) during sampling also protects the sample and prevents it from flowing through the top port in case of high pressure/flow.

To place a rubber cap simply press it axially against the hose piece until it “clicks in”. Remove it by pulling it outwards axially.

Caps in stainless steel are available as accessories (part no. 800061). They are mechanically more robust, withstand higher pressure and may be autoclaved.

To fit the steel cap compress the spring loaded lock pin, place the cap over the hose piece and release the lock pin. Make sure the lock pin has moved fully back to its initial position for a secure locking.

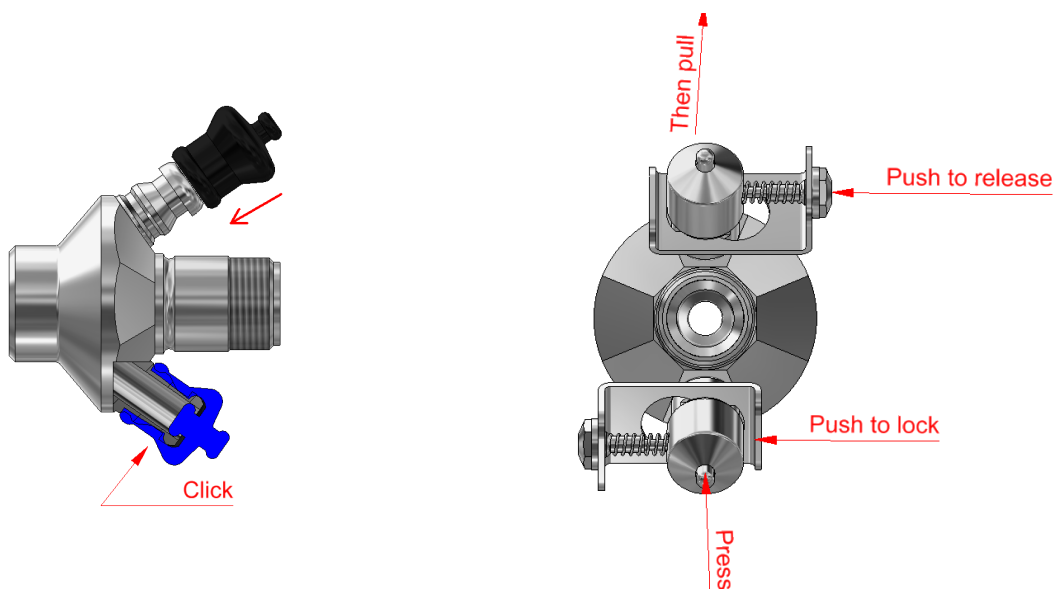



IMPORTANT

- All illustrations show a W9 sampling valve with Keofitt hose piece connections. All instructions also apply to valve versions with clamp connections; only make sure to use the corresponding fittings.
- All illustrations in the following sub-chapters show a valve head with a turn knob (type H), but the instructions also apply to the INGOLD variants and to heads with a key (type K), a handle (type Q) or a pneumatic actuator (type N). Please see chapter 3.2 for a description of the different valve head configurations.

5.1 Chemical CIP

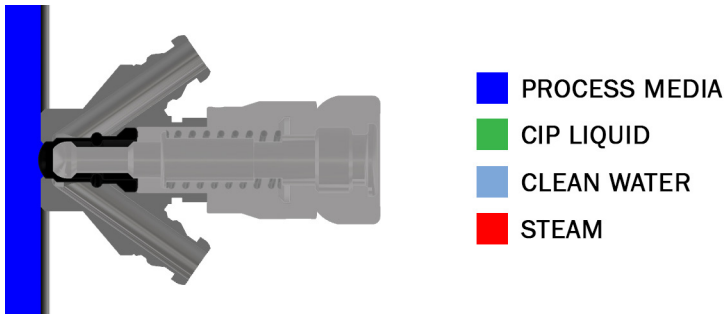
The CIP takes place with the valve remaining in its closed position. Perform the following steps:

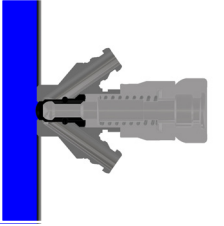
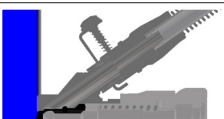

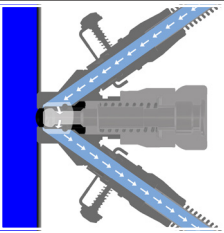
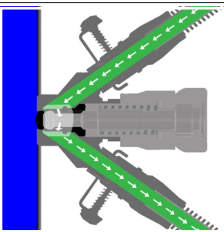
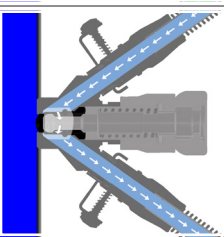
1.	Remove the plugs. (In the case of a valve with clamp connections there are no plugs supplied.)	
2.	Connect a water hose to the upper hose piece.	
3.	Connect a hose to the lower hose piece and let the hose go to a drain.	
4.	Flush with clean water.	
5.	Remove the water hose and let the CIP liquid flow through the upper hose piece. If the CIP liquid must not go to drain, circulate it or collect it in a suitable container and dispose of correctly.	
6.	Reconnect the water hose to the upper hose piece and rinse with clean water.	

If disinfection is not needed the valve is now ready for taking a sample. If disinfection is required proceed with the steps mentioned in the section “Chemical disinfection” below.

Flush with clean water after sampling. If the process media is sticky, viscous or aggressive or for any other appropriate reason, do repeat the full CIP cycle after sampling.



WARNING

- Carefully follow the guidelines given for the chemicals involved
- Always remember to use safety goggles when steaming, CIPping, taking samples and all other operations of the sampling valve

5.2 Chemical disinfection

Immediately following the CIP, perform the disinfection, if required. The disinfection takes place with the valve remaining in its closed position.

There are 2 recommended ways to carry out the disinfection:

- A) by letting the disinfectant flow through the valve chamber
- B) by filling the valve chamber with the disinfectant (advantage: smaller volume of disinfectant needed and quicker and more reliable disinfection)

Steps to perform, when adopting A:

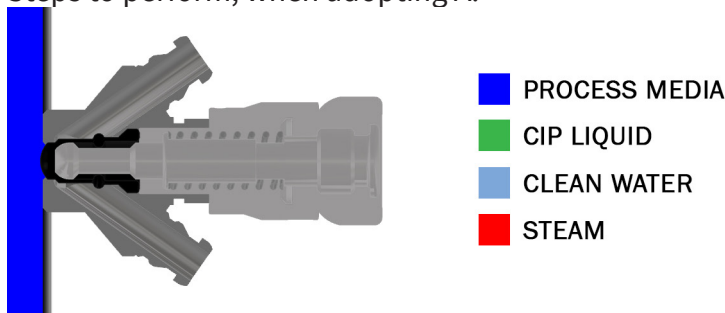

1.	Connect a hose with an empty bottle to the lower hose piece. This bottle or similar recipient is to collect the disinfectant (step 3) and the rinsing water (step 6).	
2.	Fill a flexible bottle with the defined amount of disinfectant.	
3.	Connect the flexible bottle via a hose to the upper hose piece and press the disinfectant slowly through the valve to wet the interior of the valve.	
4.	Allow the disinfectant to act for the prescribed time.	
5.	Disconnect the hose from the upper hose piece and connect a flexible bottle with cleaned water to the upper hose piece.	
6.	Rinse through the upper hose piece by squeezing the bottle, thus pressing the water through the valve chamber.	
7.	Leave the squeezed bottle connected to the hose piece and clamp the hose to avoid contamination from air being sucked in through the valve.	

Steps to perform, when adopting B:

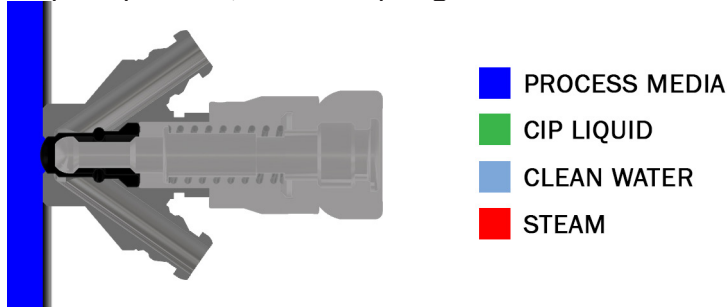

1.	Plug the lower hose piece with a rubber plug (or a steel plug). In case of a valve with mini clamp connections the closing of the outlet may be obtained by using a tri clamp blind cap (always use a gasket) or by squeezing an attached piece of tubing or by any other appropriate means.	
2.	Fill the valve chamber with the disinfectant through the upper hose piece.	
3.	Leave to act for the prescribed time.	
4.	Empty the valve chamber by unplugging the lower hose piece while holding a recipient under the valve allowing the disinfectant to flow out.	
5.	Connect a flexible bottle with cleaned water to the upper hose piece and rinse through the upper hose piece.	
6.	Leave the squeezed bottle connected to the upper hose piece and clamp the hose to avoid contamination from air being sucked in through the valve.	

The valve is now ready to take a sample. The sampling must be performed immediately after disinfection to avoid any contamination of the sample.

Flush with water after sampling. If the process media is sticky, viscous or aggressive or for any other appropriate reason, do repeat the full CIP cycle after sampling.



WARNING

- Carefully follow the guidelines given for the chemicals involved
- Always remember to use safety goggles when steaming, CIPping, taking samples and all other operations of the sampling valve

5.3 Steam sterilisation

Chemical CIP and chemical disinfection are usually not needed when using steam, as steam does it all. An exception from this is with sugary substances, which caramelize and with substances containing protein, which coagulate and burn; see chapter 2.1. In this case flushing with an appropriate fluid must precede post-sampling steaming.

Steam sterilisation takes place with the valve remaining in its closed position. Perform the following steps:

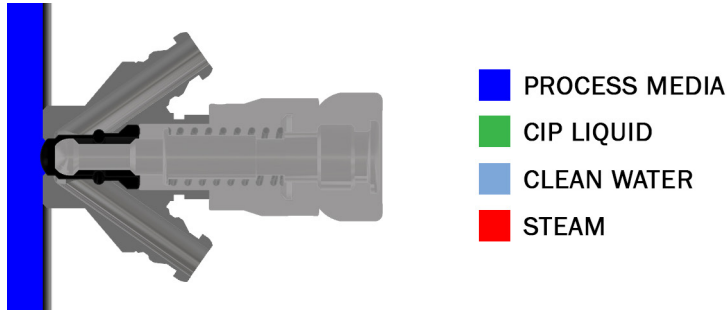

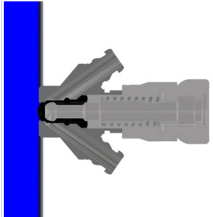
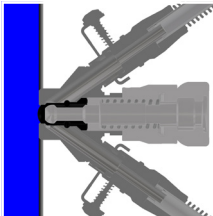
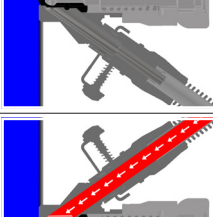
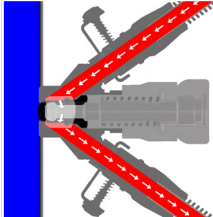
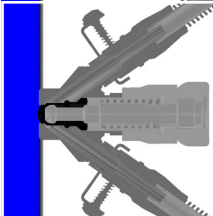
1.	Remove the plugs from the hose pieces.	
2.	Connect the steam hose to the valve's upper hose piece.	
3.	Connect a hose to the lower hose piece and let it go to drain.	
4.	Open the steam supply and let it flow through the valve for sterilisation. Allow 1 minute at 121° C (1 bar(g)).	
5.	Close the steam supply, but leave the hose in place to prevent contamination to the surroundings during sampling. If removal of steam hose is required, fit a sterile rubber or stainless steel plug onto the upper hose piece.	

The valve is now ready to take a sample. The sampling must be performed immediately after steaming to avoid any contamination of the sample.



WARNING

- During sterilisation with steam the valve will become hot and care should thus be taken when operating the valve
- The valve is designed for use in working conditions of up to 6-12 bar(g) pressure (depending on choice of valve head). It is therefore important to be aware that the rubber plug (designed for max. 3 bar(g)) or the steel plug (designed for 12 bar(g)) may be forced out at high speed, if not seated properly
- For valve heads allowed under ATEX for Group IIGD, Category 2 (zone 1) both handle and top of valve heads N and Q must be cleaned before use
- Always remember to wear safety goggles when steaming, CIPping, taking samples or any other operations of the sampling valve



IMPORTANT

- Don't attach a steam trap to the hose from the valve steam outlet (lower hose piece) as it will impede the flow of steam and hence the flushing effect, and make the sterilisation dependant on temperature only, demanding a much longer sterilisation time
- If the steam capacity is low and/or the outlet hose from the valve is short and/or with a large diameter, the temperature will drop and condensation may occur in the valve chamber. In this case a counter pressure must be established using a pressure relief valve or a needle valve at the outlet
- Leave the steam hose in place to prevent contamination from the surroundings during sampling. If removal of steam hose is required, fit a sterile rubber or stainless steel plug onto the upper hose piece

5.4 Sampling

Prepare a recipient for your sample.



For aseptic sampling use steam and a Keofitt Aseptic Sampling Bag (available in different sizes; please see datasheet on www.keofitt.dk). Leave the steam hose in place to prevent contamination from the surroundings during sampling.

For all other sampling use a Keofitt Sterile Sampling Bag or a Spike Bag, which provides a closed flow path for your sample protected against the surroundings. Alternatives are bottles with a screw cap, jars or any other available container. If removal of steam/CIP hose is required, fit a sterile rubber or stainless steel plug onto the upper hose piece

There are 4 means of opening the sampling valve depending on valve head type:

1. Turn knob
2. Key ring
3. Lever handle
4. Pneumatic activation

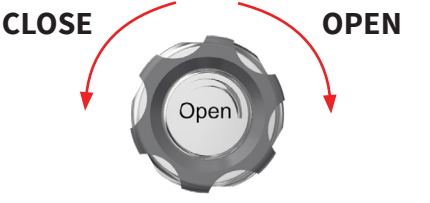
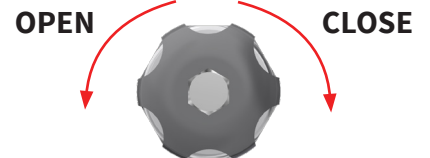
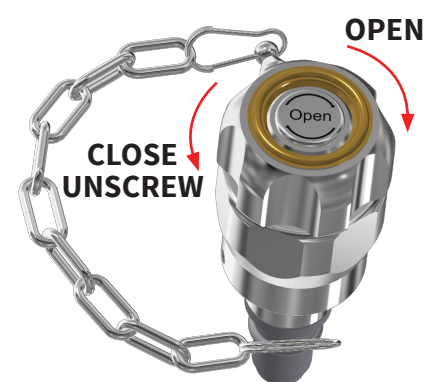
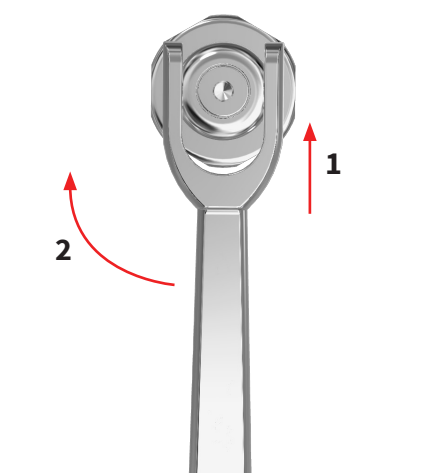
They are all explained in the following:

Valve head	Illustration	Instructions
Turn knob Type H		<p>To fully open the sampling valve, turn the knob clockwise nearly a full turn; see arrow marking on the center base plate at the turn knob.</p> <p>To close the valve, turn the knob counter clockwise. When closed the turn knob sits loose on the spindle, since a spring provides the closing force on the valve.</p> <p>NOTE: The valve opens in the opposite direction compared to a normal water tap. This is a safety precaution to avoid unscrewing the valve head from the valve body instead of opening the valve.</p>
Turn knob Type B		<p>This valve has no spring action and opens and closes like a normal water tap.</p> <p>To open the sampling valve, turn the knob counter clockwise; see arrow marking on the center base plate at the turn knob.</p>
Key ring Type K		<p>Unlike the type H and type B, which have turn knobs made from synthetic material, the key ring version has a metal ring serving as turn knob.</p> <p>The key ring version allows you to unscrew and remove the turn knob in order to prevent unauthorized opening of the sampling valve.</p> <p>To open the valve first screw the key ring onto the threaded end of the valve stem. Keep on turning until the valve opens.</p> <p>Close the valve by turning the ring anticlockwise. Unscrew key ring completely by keeping on turning it anticlockwise until it disengages, and it may be removed.</p>
Lever handle Type Q		<p>Enter the lever handle into the groove of the valve head. Move the tip of the handle slowly away from the valve head and into a position co-axial with the valve head; the valve is now fully open</p> <p>For closing, there are 2 options:</p> <ol style="list-style-type: none"> 1. Continue the movement of the handle another 90 degrees; the valve is now closed, and the lever handle locked in position 2. Reverse the initial movement of the handle. The valve is now closed, and you may remove the lever handle to avoid it falling out. <p>Removing the lever handle after sampling impedes unintentional opening of the valve.</p>
Pneumatic Type N		<p>This valve head is usually operated pneumatically. It may however also be operated manually using a lever handle.</p> <p>See Type Q for instructions.</p>

Pneumatic adjustable
Type N



The “adjustable” feature allows you to set the maximum stroke length of the valve when it opens. In this way the sample flow and sample volume may be more easily controlled, particularly with a relatively high pressure on the process side. Seen from the external end of the valve head, screw the lock-nut fully against the bigger adjustment hex-nut. Then screw the hex-nut into the pneumatic cylinder until resistance. Setting the lever now in its axial position will not open the valve. Keep the lever in this position and unscrew the hex-nut until it touches the lever. Then lower the lever and unscrew the hex-nut a half turn more. Activate the lever and note the amount of flow. Repeat this operation until the wanted flowrate is reached. Remove the lever handle and operate the valve pneumatically. Check if the flowrate is still correct and adjust if needed. Finally secure the position by tightening the locknut against the pneumatic cylinder.

NOTE:
The degree of opening using the lever handle is not exactly the same as when opened pneumatically.

Take the sample immediately after cleaning/disinfection/sterilisation performing the following steps:

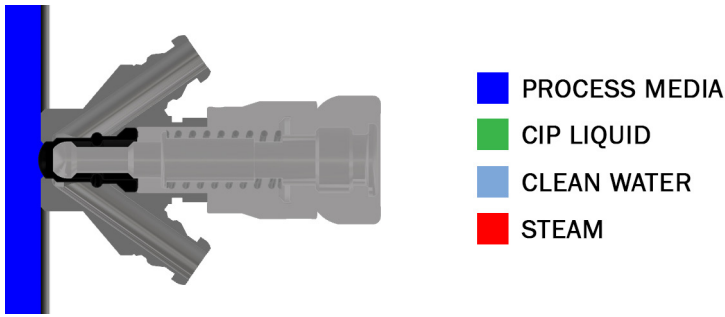

1.	<p>Open the valve slowly and take the sample. NB! In order to flush the valve seat before sampling you may choose to let the first few seconds of flow go to drain.</p>	
2.	<p>Close the valve after the sample has been taken.</p>	
3.	<p>Clean the valve by flushing with steam, water or hot water.</p>	

If the process media is sticky, viscous or aggressive or for any other appropriate reason, do repeat a full CIP cycle after sampling in case steam is not available and flushing with water prove insufficient.



WARNING

- When sampling at a high pressure and/or with a low viscosity process media it may flow rapidly into the sample recipient. Therefore open the valve slowly. Special care must be taken with pneumatically operated valves, as they open abruptly. If problematic, consider adjustable actuators.
- Always remember to wear safety goggles when steaming, CIPping, taking samples or any other operations of the sampling valve

6. TECHNICAL DATA

6.1 Material

Valve body:	AISI 316L (1.4404 or 1.4435 depending on version. Please refer to corresponding datasheet)
Valve head:	AISI 316L (1.4404)
Membrane:	Silicone (grey) EPDM (black) PTFE (white) FFKM (white)

6.2 Certificate

3-A:	Conforming to 3-A Sanitary Standards for 55-02 (Boot Seal-Type Valves)
Valve body:	A 6-digit code is marked on the valve body. This code refers to a 3.1 certificate which accompanies every consignment of valve bodies. The 3.1 certificate is available at the Keofitt Online Service Center on www.keofitt.dk . Click Certificates and then 3.1.
Membrane:	Silicone acc. to FDA, 3A, EC1935, USP88 Class VI, BfR XV, EC2023 EPDM acc. to FDA, 3A, EC1935, USP88 Class VI, EC2023 PTFE acc. to FDA, EU10, EC1935, USP88 Class VI, EC2023 FFKM acc. to FDA, USP Class IV, EC1935, EC2023

6.3 Pressure (max.)

Working pressure:	6 bar(g) / 87 psi(g) (valve head type B 12 bar(g) / 174 psi(g))
Rubber plug	3 bar(g) / 44 psi(g)
Steel plug	12 bar(g) / 174 psi(g)

6.4 Temperature

Steam:	Sterilisation using dry, saturated steam at 121 C / 250 F and 1 bar(g). Dry, saturated steam at temperatures up to 134 C / 272 F and 2 bar(g) is possible, but might reduce the service life of the membrane.
Process medium:	The acceptable operating temperature range for the process medium depends on the choice of membrane as follows: <ul style="list-style-type: none">• Silicone: 0 C to 130°C (32-265°F)• EPDM: 0 C to 130°C (32-265°F)• PTFE: 0 C to 150°C (32-300°F)• FFKM: 0 C to 250°C (32-482°F)

Sub-zero Centigrade operation is possible with all membranes. Please consult your local distributor og KEOFITT if occation arises.

Ambient:	The range of acceptable ambient temperatures is limited by the polymer handle and the pneumatic cylinder to -40 C to 80 C.
----------	--

6.5 Surface finish

Internal: Electropolished
 $Ra \leq 0.5 \mu\text{m} / 20 \mu\text{inch}$

The mean and standard deviation are statistical values measured for a given production batch:

$Ra(\text{mean}) = 0.2 \mu\text{m} / 8 \mu\text{inch}$

$Ra(\text{std. deviation}) = 0.08 \mu\text{m} / 3 \mu\text{inch}$

Valves with internal electropolishing are identified by an E preceding the serial number e.g. E12345678

External: Electropolished

The surface roughness is measured for each valve at 4 critical places (the valve body process surface, the valve chamber and each of the two ports). A serial number identifies each valve body.

A specific surface roughness certificate is supplied with every valve. A general surface finish certificate copy is available on www.keofitt.dk

6.6 Viscosity

Viscosity range: For W9 variants: 0-1000 cP, with particles up to 3mm in diameter.
For INGOLD variants: 0-800 cP, with particles up to 2 mm in diameter.
Higher viscosity liquids may be sampled, only will the sampling take longer.

6.7 Flow

This chapter describes the pressure drop across a W9 valve. There is no data available for the INGOLD variant, but the pressure drop could be expected to be somewhat higher due to the longer flowpath of the INGOLD valve.

The graphs below illustrate (for water at 20°C/68°F) the following:

- Pressure drop across valve*) as a function of the flow for different positions of the turn knob
- Pressure drop for flow between the inlet and outlet ports (CIP ports)

*) From tank/pipe side to lower port (outlet) with upper port blocked.

Based on the tank pressure and the requested sample flow the graphs may be used to get an indication of to which degree the valve must be opened.

W9 pressure drop

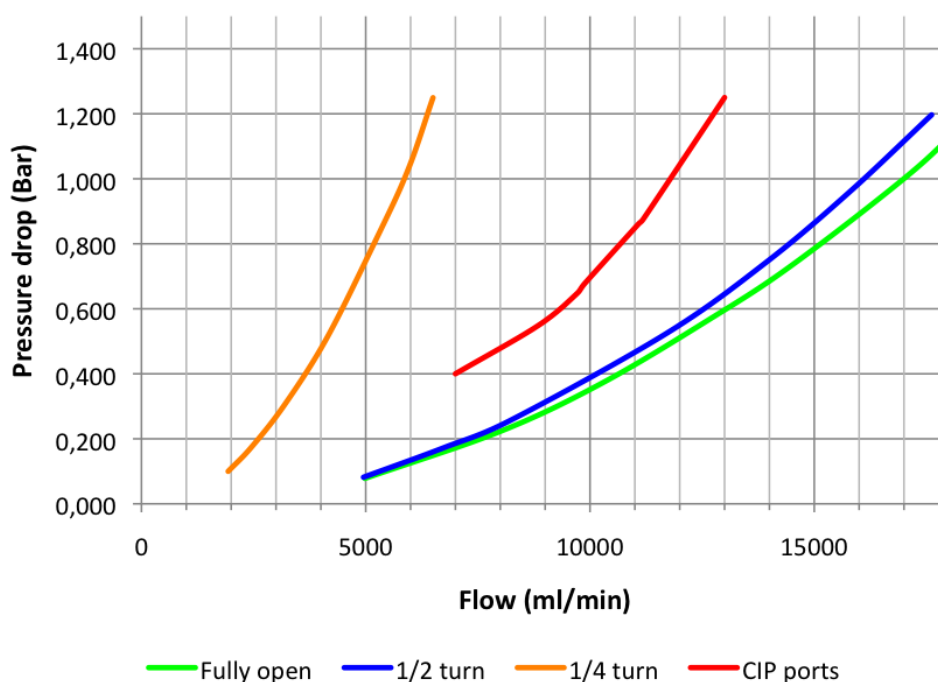

The generally accepted sampling time is around 10 sec. for small samples and around 30 sec. for larger samples. As usual sample sizes are between 100 ml and 1000 ml the needed flow lies from 600 to 2000 ml/min.























































As the pressure on the sample side usually is 0 bar(g) the pressure drop across the valve equals the process pressure (tank pressure or line pressure).

The volume flow through a valve is given by: $k_v = Q \sqrt{\frac{\rho}{1000 \times \Delta p}}$

Symbol	Unit	Description
k_v	m ³ /h	Flow in m ³ /h through a valve at a pressure drop of 1 bar as defined in VDE/VDI norm 2173.
Q	m ³ /h	Volume flow through the valve
ρ	kg/dm ³	Density of the fluid. For Water it is 1.
Δp	bar	Pressure drop across valve. As the gauge pressure at the valve outlet usually is 0 bar(g) the pressure drop is often equal to the gauge pressure at the input (the process side)

7. VALVE BODIES





KEOFITT CLASSIC W9 SAMPLING VALVE - BODIES

		Connection bodies					
		Varivent Ø50	Varivent Ø68	Clamp ½"	Clamp 1"	Clamp 2"	Thread
W9 BODIES	Hose Piece	 850008	 850009	 850036	 850021	 850003	 850031 DIN 11851 850040
	Mini Tri-Clamp	 On request	 850013	 850039	 850022 850025	 850026 850005	 On request
	Thread M16x1,5	 850015	 850016	 850018	 On request	 On request	 On request
	Welding Ends	 850007	 850019	 On request	 On request	 On request	 On request
	Tank Welding Ø28	 850001	 850011	 850014	 850027*	 850028*	 On request
	Pipe Welding 1"	 850010	 On request	 On request	 On request	 On request	 On request
	Pipe Welding NW25	 850018	 On request	 On request	 On request	 On request	 On request
	In-Line Vertical	 850019	 On request	 On request	 On request	 On request	 On request
	In-Line Horizontal	 On request	 On request	 On request	 On request	 On request	 On request

* ON REQUEST ONLY!

For further product information - material, dimensions etc. - please refer to the specific datasheet at www.keofitt.dk

KEOFITT CLASSIC "INGOLD" SAMPLING VALVE - BODIES

INGOLD BODIES		
STANDARD FOR 40 MM PORT LENGTH*		
Hose Piece	Mini Tri-Clamp	Thread M16x1,5
On request	 3100002	On request
On request	 3100005	On request
STANDARD FOR 52 MM PORT LENGTH*		
On request	 3200002	On request
On request	 3200005	On request

* OTHER PORT LENGTH - PLEASE SPECIFY

* OTHER PORT LENGTH - PLEASE SPECIFY

For further product information - material, dimensions etc. - please refer to the specific datasheet at www.keofitt.dk

















8. VALVE HEADS

KEOFITT CLASSIC W9 SAMPLING VALVE - HEADS

W9 HEADS		Type H Turn knob	Type H Turn knob with Microport option	Type K Key ring	Type K Key ring with Microport option	Type 0 Lever handle	Type N Pneumatic 0-6 bar	Type N Pneumatic, Adjustable 0-6 bar	Type B No spring 0-12 bar(g)
Silicone	600041	600048	600042	600049	600043	600044	600045	600047	600047F
EPDM	600041E	600048E	600042E	600049E	600043E	600044E	600045E	600047E	600047FE
FFKM	600041F	600048F	600042F	600049F	600043F	600044F	600045F	600047F	600047FF
PTFE	855541	855542	855543	855544	855545	855546	855547	855548	855549

For further product information - material, dimensions etc. - please refer to the specific datasheet at www.keofitt.dk

KEOFITT CLASSIC "INGOLD" SAMPLING VALVE - HEADS

INGOLD HEADS		Type H Turn knob 0-6 bar(g)	Type Q Lever handle 0-6 bar(g)	Type N Lever handle Pneumatic 0-6 bar(g)	Type N Pneumatic, Adjustable 0-6 bar
Silicone	 310041	 310043	 310044	 320044	On request
EPDM	 310041E	 310043E	 310044E	 320044E	On request
PTFE	 310041E	 310043E	 310044E	 320044E	On request
	 315541	 315543	 315544	 325544	

For further product information - material, dimensions etc. - please refer to the specific datasheet at www.keofitt.d

























9. PARTS & ACCESSORIES

KEOFITT CLASSIC W9 - PARTS & ACCESSORIES

W9™ PARTS & ACCESSORIES		W9™ PARTS & ACCESSORIES		W9™ PARTS & ACCESSORIES		W9™ PARTS & ACCESSORIES		W9™ PARTS & ACCESSORIES		W9™ PARTS & ACCESSORIES		W9™ PARTS & ACCESSORIES		W9™ PARTS & ACCESSORIES			
O-Rings	400208 O-RING 68 FDA W9 SILICONE	600051 W9 SILICONE	700061 STEEL CAP W9	550057 ADAPTOR KÄRCHER	300021 CLAMP/PTEE 10/8	For valve heads	600076 KEY RING W9	600064 CHAIN W9	900047 PTEE 10/8	400308 EPDM 42X3 FDA	600052 W9 EPDM	700070 TUBE FITTING WL	600062 RUBBER CAP W9	550002 PTEE W/QC 0.5M	600149 BUSHING W9	600066 CHAIN W9	900069 WICK W9 MP
O-Rings	550184 O-RING FESTO	600251 SILICONE W9 MP	700071 TUBE FITTING PTEE	800013 QC W9 SPIKE	550003 PTEE W/QC 1.0M	600170 Q HANDLE	600073 FERRULES	900075 CLAMP 1/2"	600825 SILIC. 7.1X1.6 FDA	600252 EPDM W9 MP	700084 BARB 4MM	800058 COIL W9	550004 PTEE W/TC 0.5M	600255 TOOL PTEE W9	400166 PROX SENSOR	900086 CLAMP 1"	
O-Rings	600825E 7.1X1.6 EPDM	600053 FRM W9/SIMPLEX	700085 BARB 8.5 X 6MM	800061 QC W9 PLUG	550005 PTEE W/TC 1.0M	600370 Q HANDLE	600266 PROX SENSOR		600830 10.3X2.4 SILIC	850055 PTEE W9/SIMPLEX		800070 QC W9 WL	800014 ADAPTER TC/1"	900018 TOMMY BAR	600067 PROX SENSOR KIT		
O-Rings	600074 GASKET 3/4"	900074 GASKET 3/4"	800083 QC W9 TC	800082 QC W9 HOSE ID 7	900013 MINI CLAMP SPIKE		700108 HOSE PIECE W9		800830E 10.3X2.4 EPDM			800091 QC W9 PTEE	900096 ADAPTER W9/TC	800052 HP/HP W9			
O-Rings	900091 GASKET 1"	900087 GASKET 1/2"	800086 QC W9 M4 HP	900045 ADAPTER W9/ISO			800075 WL F/PTEE		900029 21X4 EPDM				800045 ADAPTER W9/ISO	900008 SOCKET ALU			
Misc.																	900022 NEEDLE W9

For further product information - material, dimensions etc. - please refer to the specific datasheet at www.keofitt.dk

KEOFITT CLASSIC "INGOLD" - PARTS & ACCESSORIES

W9™ INGOLD PARTS & ACCESSORIES				
O-Rings	 <p>300118 EPDM 20.24x2.62</p>	 <p>310051 I40 SILICONE</p>	 <p>300119 20.24x2.62 FDA</p>	 <p>850820 PISTON RING NBR</p>
Membranes	 <p>310051 I40 SILICONE</p>	 <p>310052 I40 EPDM</p>	 <p>310055 I40 PTFE</p>	 <p>320052 I52 EPDM</p>
For mini tri-clamp	 <p>300021 CLAMP/PTFE 10/8</p>	 <p>550004 PTFE W/TC 0.5M</p>	 <p>550005 PTFE W/TC 1.0M</p>	 <p>800083 QC W9 TC</p>
For valve heads	 <p>300255 TOOL PTFE INGOLD</p>	 <p>600149 BUSHING W9</p>	 <p>600170 Q HANDLE</p>	 <p>900018 TOMMY BAR</p>
Misc.	 <p>320030 ADAPT. 30 F/I52</p>	 <p>3200540 ADAPT. 40 F/I52</p>	 <p>850822 SLIDE BEARING</p>	 <p>900075 CLAMP 1/2"</p>
				 <p>600170 Q HANDLE</p>
				 <p>800014 ADAPTER TC/1"</p>
				 <p>900013 MINICLAMP SPIKE</p>
				 <p>900096 ADAPTER W9/TC</p>

For further product information - material, dimensions etc. - please refer to the specific datasheet at www.keofitt.dk

10.MOUNTING INSTRUCTIONS

10.1 Location

The valve should always be located with its centre line in a horizontal position and with the two hose pieces in a vertical position with the arrow pointing upwards as shown on the figure. Only with this orientation the valve will be self draining.



IMPORTANT

- The tank-side of the valve body must be positioned flush with the inside of the tank or the pipe in order to avoid any dead space.

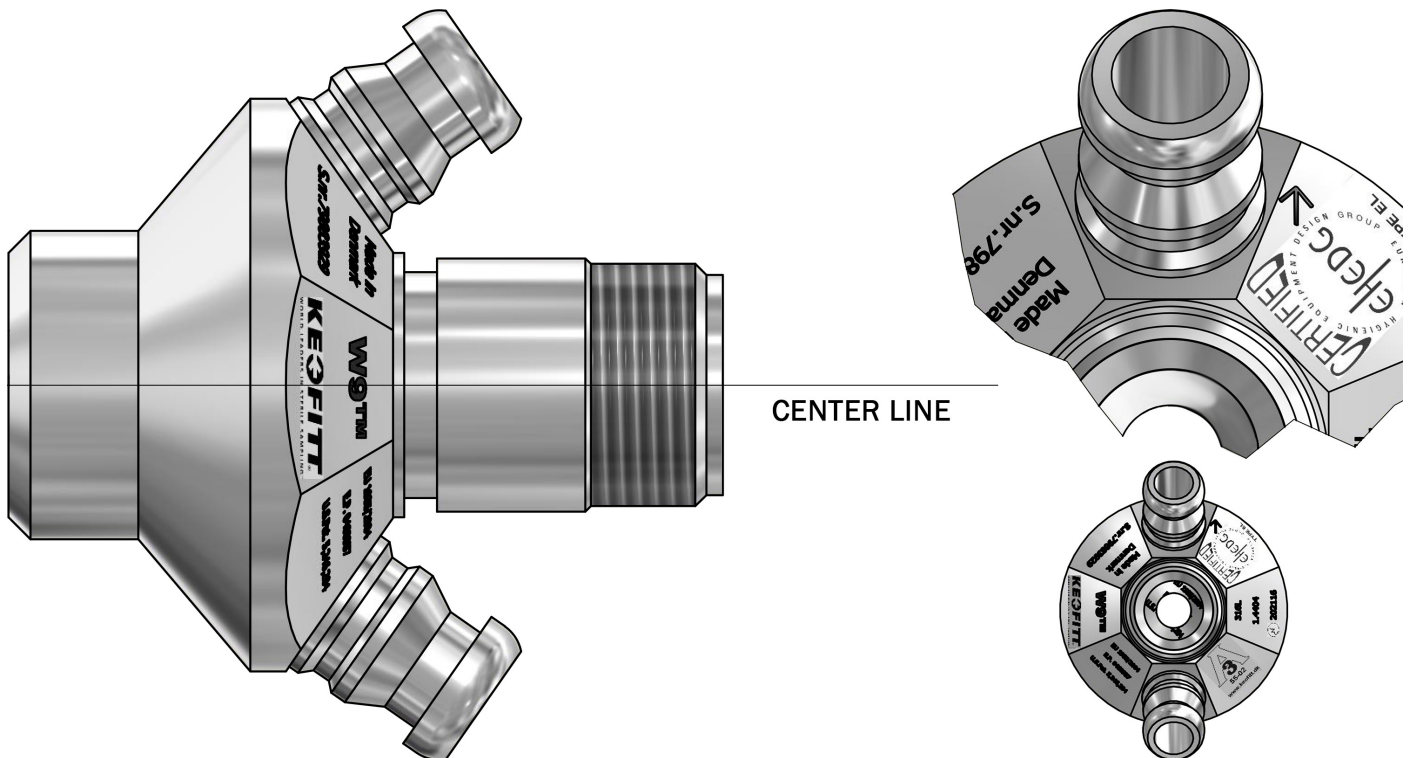

10.2 Before welding

Remember to disassemble the valve body and head. The valve body and head must be separated during welding. Rubber plugs, chain and membrane must be removed from the valve body, as otherwise heat from the welding process will damage them.

11. WELDING INSTRUCTIONS

Valves for welding are available in two types: T (tank) and P (pipe).

1. For type T (tank) it is necessary to drill a hole $\varnothing 28$ mm into the tank wall, and then fit the valve into this hole flush with the inside of the tank. Welding should be carried out as a penetration welding.

Material thickness less than 4 mm: Weld from inside. Material thickness greater than 4 mm: Weld from both outside and inside.

Since type T has a solid end piece, the valve will not be damaged by penetration welding. However, the use of purge gas in the form of either Argon or Formier gas is recommended in order to give the best result.

2. For type P (pipe) penetration welding must be carried out from outside. The valve is machined with a recess-like shoulder on the outside of the end piece which gives approximately the same material thickness (1.5mm material thickness) as in the pipe wall. This machined shoulder can be modified according to the customer's wishes.



IMPORTANT!

- When grinding/polishing the internal weld, the valve seat must not be touched.

11.1 Welding method

The welding result will be best if the following method is used:

A collar is made on the pipe section so that the valve has a flat contact face. This flaring must look like a T-piece, as shown in the example below.



- The pipe section and the valve's hose pieces are sealed with sponge rubber or similar.
- Purge gas such as Argon or Formier gas is fed through the valve body into the pipe section and the system is now filled with 6 times the estimated volume of the pipe section. All O_2 is thus expelled from the system and welding can commence.
- Welding must take place only with the purge gas continually flowing in the system.
- The gas remains in the system until the item is lukewarm, after which the set-up can be dismantled.

11.2 Guideline welding values

W9™ valve welded onto a 2 mm 3" dairy pipe: 50-60 Amp.

It should be noted that Keofitt can supply all P type valves welded onto a pipe section according to customer specifications. Flaring is thus avoided and only a girth weld is required.

12. BLOCK DIAGRAMS

This chapter only illustrates different ways to attach a W9 valve to the process line. INGOLD valves are fitted into a standardised INGOLD connector with a length of 40 mm. or 52 mm.

12.1 Keofitt valve type T (tank)

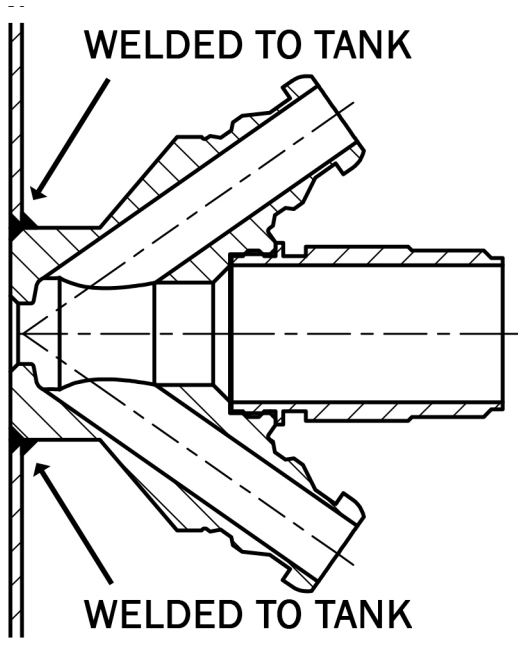

12.2 Keofitt valve type P (pipe)

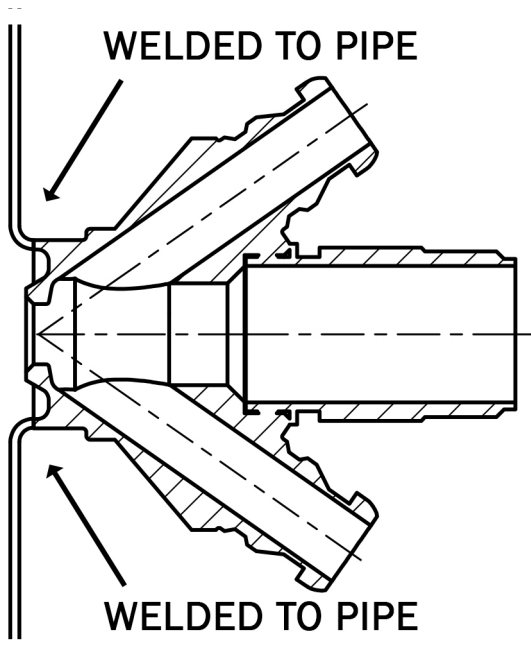

12.3 Keofitt valve type P (pipe connection vertical) Inline

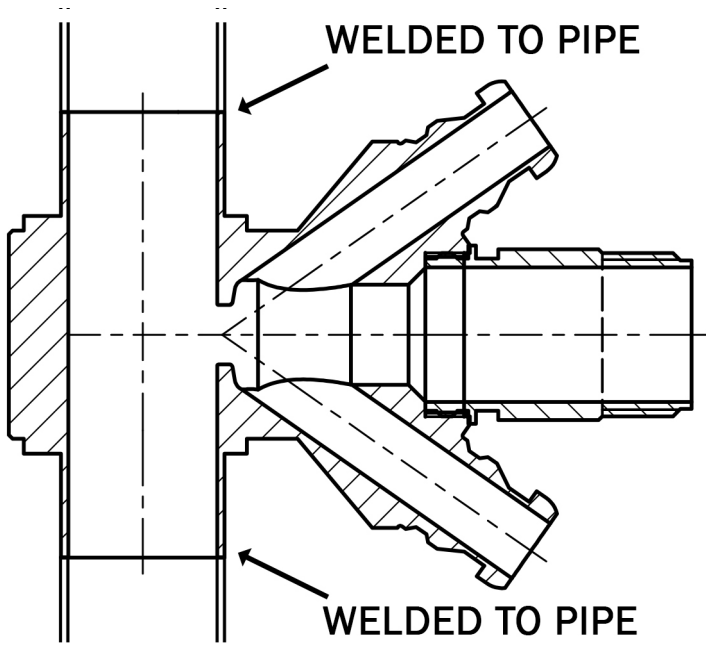

12.4 Keofitt valve type clamp connection

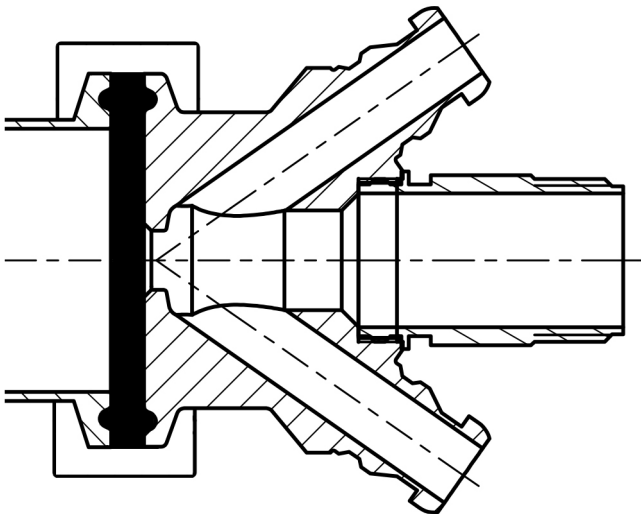

12.5 Keofitt valve type Varivent®

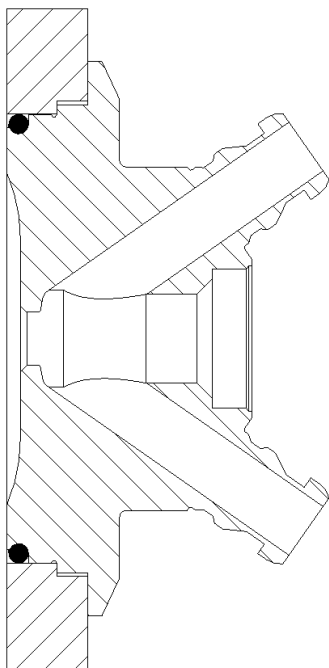

12.6 Keofitt valve type thread

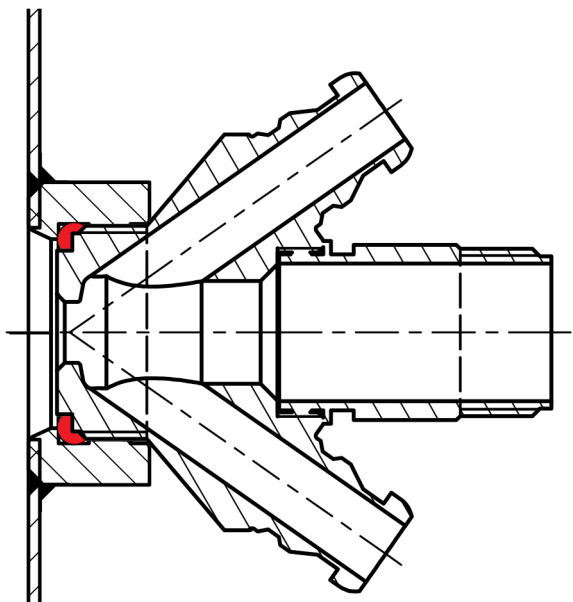

13. MAINTENANCE

13.1 Maintenance

All membranes must be inspected between batches.

The EPDM and Silicone membranes should be replaced at every batch change or at least every 2-3 months. PTFE and FFKM membranes should be replaced every 12 months. In the event of intensive sterilisation and cleaning it may be necessary to replace it more frequently. The appropriate replacement frequency should be determined by the user by starting with short intervals and continuously extend the time in use until one reaches the limit of the membrane's durability. Based on the desired safety margin the user then decides on the replacement interval to adapt.

For valve heads with Micro Port, approx. 5-10 samples may be drawn off per membrane at 5-2 bar(g) respectively (more piercings are acceptable at lower pressure). See chapter 3.5 Membranes for more information.

The rubber plug must be replaced at least once every six months. In each individual case a standard operating procedure including maintenance intervals should be endorsed based on experience. For disassembly of valve body and valve head, see instructions in chapter 13.3.

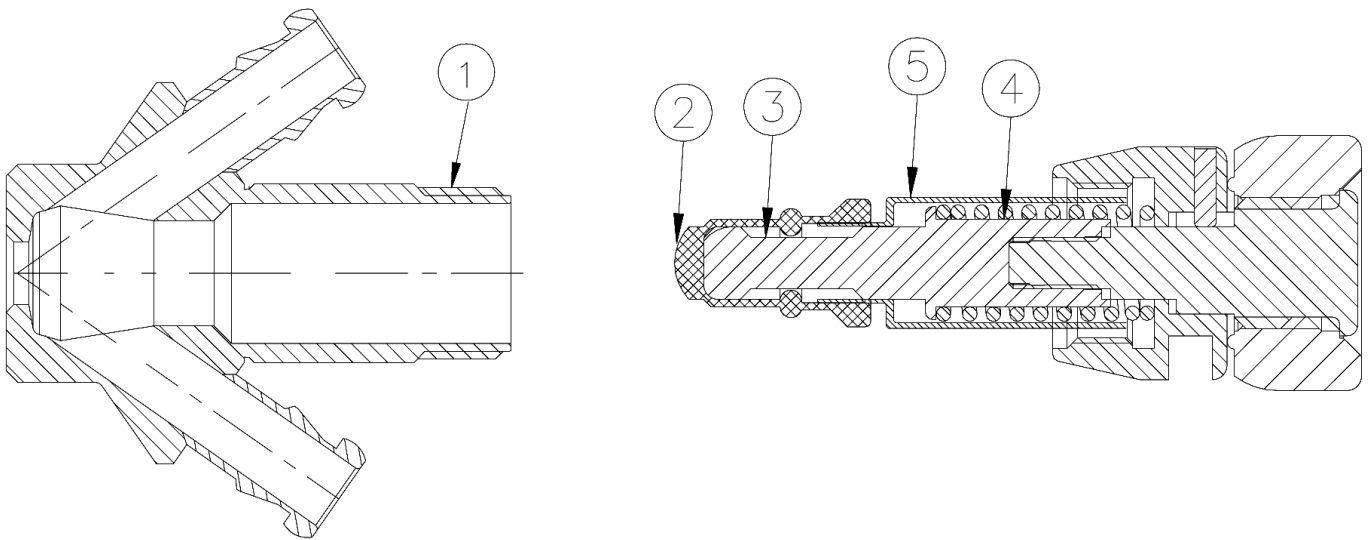

13.2 Spare parts list

1. Valve body
2. Membrane Silicone (grey), Membrane EPDM (black), Membranes PTFE and FFKM (white)
3. Lower stem (slightly different shape for PTFE membrane)
4. Spring (except type B)
5. Steel bushing

13.3 Disassembly and assembly of valve body and head

For inspection of the membrane or for cleaning purposes it is necessary to disassemble the valve (separate the valve head from the valve body).

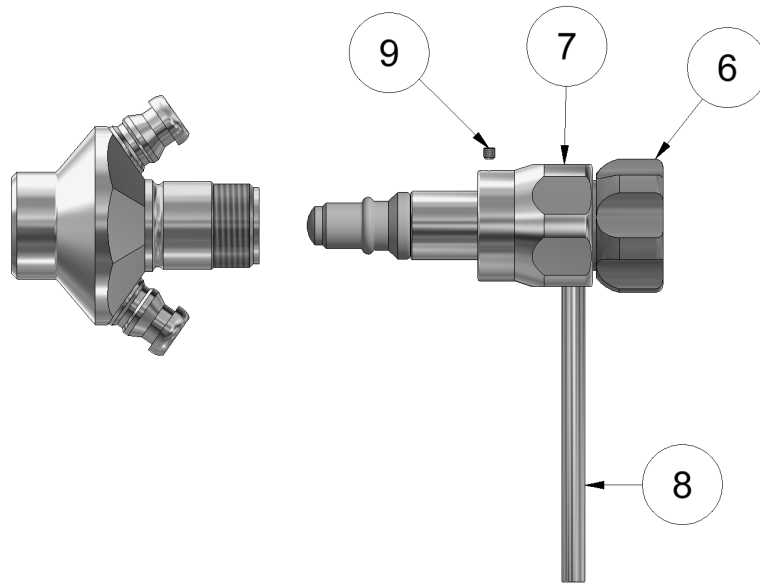

In order to disassemble and assemble the valve body and valve head please perform the following operations:

1. Set the valve head at the OPEN position. For types H and K this is done by turning pos. 6 clockwise.
2. If fitted loosen or unscrew the small set screw (pointer screw pos. 9)
3. Remove the valve head pos. 5. DON'T use a wrench. A tommy bar pos. 8 should be used for disassembly and assembly. This is carried out by unscrewing pos. 7 until loose and then pulling the valve head off.
4. Refit the valve head (in the OPEN position) once the necessary parts have been replaced. Care should be taken not to damage the threads. Use suitable lubricant.
5. Tighten with tommy bar.
6. Fit and tighten the set screw, if wanted/needed; it prevents the valve head from being inadvertently unscrewed (applies only to type K, H and B).

NOTE

The Tommy bar has been provided to avoid the risk of tightening the nut too much, if using a big wrench.

When using the Tommy bar you may use your full forces by hand.



IMPORTANT

- In the rare and unlikely event the neck of the valve body comes loose (gets unscrewed together with the valve head) please contact your dealer or Keofitt to obtain a small tool and instructions of how to reinsert and secure the valve neck.



WARNING!

- When replacing the membrane, set the valve head in the OPEN position before it is unscrewed and pulled out of the valve body. Omitting to do so may result in twisting and cutting of the membrane.
- Don't use a big wrench to tighten the valve head to the valve body.
- Don't clean the valve head in an ultrasonic bath or by immersing it in a degreasing liquid, as it will impede the proper functioning of the screw action. When in doubt, contact your local Keofitt dealer.
- When assembling the valve head and body grease the thread slightly with a lubricant compatible with your production

13.4 Replacing a rubber membrane

The membrane must be replaced a regular intervals determined by the operating conditions of the sampling valve.

As each application is different the customers must establish their own replacement scheme. Start with very short replacement intervals, keep the used membranes for reference and extend the intervals until the condition of the the used membrane is such that it cannot safely be used anymore. Establish then a slightly shorter replacement interval to allow some safety margin.

Replacing the membrane is done as follows:

1. Unscrew the valve head as explained in chapter 13.3.
2. Turn the valve head to its CLOSED position.
3. Hold on to the base of the membrane and pull it off the stem
4. Fit a new membrane by pressing it onto the stem
5. Screw the valve head on to the valve body as explained in chapter 13.3

13.5 Replacing a PTFE membrane

The description and illustrations below show a type Q valve head, but the instructions also apply to other valve head types.

To remove an old membrane from the valve head:

1. OPEN the valve (lever position as in illustration A).
2. Unscrew the valve head from the valve body as described in chapter 13.2.
3. CLOSE valve head (illustration A).
4. Push the membrane and bushing apart (illustration B) until the tool for membrane fits under it.
5. Insert tool for membrane, between the membrane and the bushing (illustration B).
6. OPEN valve head (illustration C).
7. Now the membrane is loosened from the valve head and can be replaced.

To attach a new membrane to the valve head:

8. Set the valve head to CLOSED position (lever position as in illustration B).
9. Place the new membrane on valve head.
10. Mount the membrane bushing with the new Teflon membrane by pressing the tip of the membrane with your hand until it clicks.
11. Set the valve head in OPEN position (lever position as in illustration A).
12. Insert the valve head into the valve body as described in chapter 13.3..
13. CLOSE valve head.



IMPORTANT

- Once the membrane has been removed from the valve head the click system in the membrane might be damaged. Therefore the membrane might be unsafe for further use and it is recommended not to use the membrane again.
- Do not use hammer or other tool that might scratch the surface of the membrane.

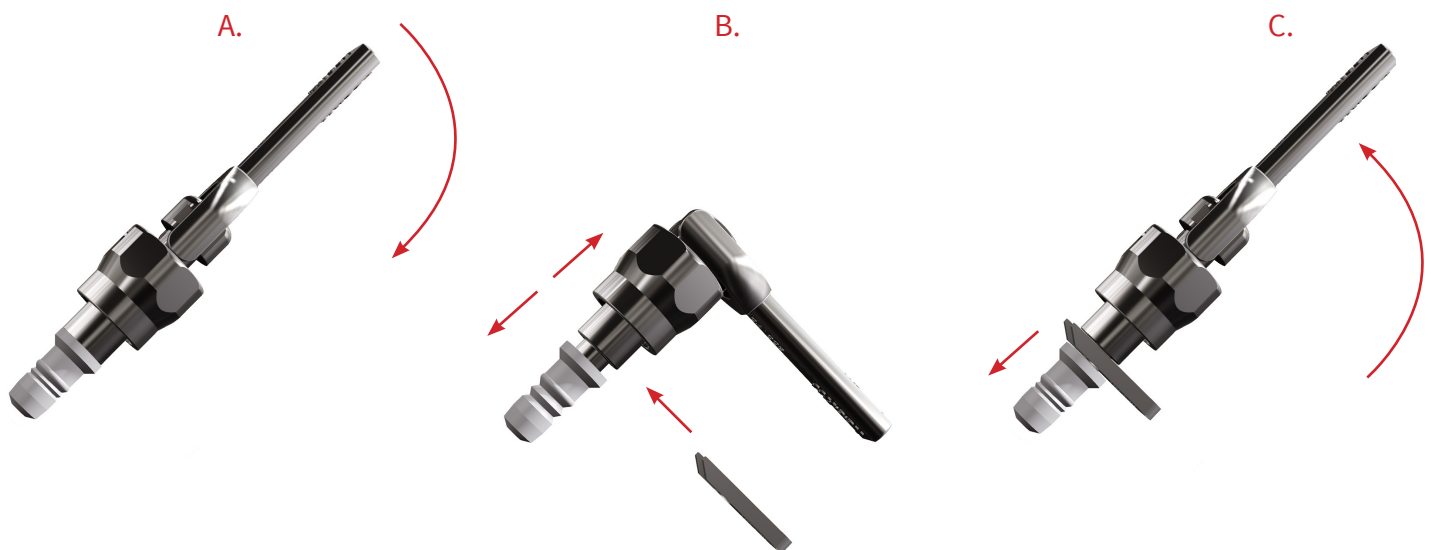

13.6 Regrease the head spindle

Over time the turn knob may become harder to turn, which may be remedied by regreasing the threaded part of the turn knob. Perform the following steps to take the valve head apart after having separated it from the valve body as explained in chapter 13.3:

- Set the valve head in CLOSED position
- Pull off the membrane
- Remove the bushing
- Fix the lower stem in a vice using soft jaws
- Unscrew the valve head top using the tommy bar (hold it back when it gets loose, as the spring will push it out)
- Pull by the knob to separate it from the union nut
- Unscrew the upper stem from the turn knob
- Lubricate the upper stem's threaded part in contact with the turn knob

Assembly is the same in reverse order, but please note:

- Discard the membrane and replace with a new one
- Push the membrane and the bushing together so that the membrane is situated against the shoulder of the bushing

14. FAILURE MODES

If the membrane is not replaced with a new one at regular intervals (depending on the application), it may eventually break, usually around the tip and more seldom along the side.

14.1 Broken membrane tip:

This failure usually causes product to leak from the process side and more or less product will flow out through the lower port, also when the valve is in closed position. As such the valve port acts as a leakage hole (weep hole).

14.2 Broken membrane side:

A longitudinal slit in the membrane is a rare incident and will only occur if the membrane has been kept in operation far beyond its expected service life.

Should it happen, product will during sampling enter the cavity between the internal surface of the membrane and the rod operating the membrane. As there is no significant pressure in the valve chamber during sampling product will only flow slowly through the slit and will eventually leak between the head union nut (pos. 7) and the turn knob (pos. 6). However, this is likely to take many rounds of samplings due to the short sampling time and the very low pressure on the external side of the membrane.

The valve is not foreseen with a leakage hole in the valve head as the risk of building-up of dirt inside the valve head from such a hole does not outweigh the manageable consequences of a broken membrane side.

The effect of such a failure will be an accumulation of a small quantity of product, which cannot be removed during the ordinary post-sampling cleaning or steaming. The consequence of this is a risk of contaminating samples taken after the failure occurred. However, the risk of contaminating the process side is considered to be negligible.

14.3 Cleaning the valve after a failure:

In case of any of the above failures the valve needs to be completely taken apart and cleaned properly using a non-abrasive cleaning agent by performing the following sequence of operations (the choice of cleaning agent is for the user to decide as it depends on the product in the process line):

1. Unscrew the valve head from the valve body as explained in chapter 13.3
2. Disassemble the valve head as explained in chapter 13.6
3. Clean all individual components from the disassembled valve head
4. Clean the valve body
5. Assemble the valve head as explained in chapter 13.6 and fit a new membrane
6. Fit the valve head to the valve body as explained in chapter 13.3

15. CHANGE FROM SILICONE/EPDM/FFKM TO PTFE MEMBRANE

All rubber membranes (Silicone/EPDM/FFKM) are interchangeable.

To change from a rubber membrane to a PTFE membrane please contact your local Keofitt dealer or Keofitt directly.

16. MEMBRANES

16.1 Silicone membrane - art. no. 600051



10 PC MEMBRANE W9/SIMPLEX SILICONE, GREY

ART. NO. 600051

GENERAL



KEOFITT has the widest selection of spare parts and accessories to complete your sampling system



Compatible with all KEOFIT W9 & Simplex valve heads for silicone, EPDM & FFKM membrane



The patented membrane design is an essential part of the hygienic design of the KEOFIT sampling valves



It allows for optimal exposure to CIP and SIP media while also integrating the capacity to remove the membrane from the valve body without the use of tools

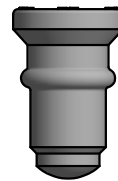

FEATURES



Compatible with all KEOFIT W9 & Simplex valve heads for silicone, EPDM & FFKM membrane

CERTIFICATION*

FDA · USP · EU 1935/2004

TECHNICAL DATA

Type:	Silicone (QBF-65 - grey)
Hardness (°Sha):	70 ±3
Tensile strength (MPa):	Min. 8,5
Elongation at break (%):	550 ±80
Density (g/cm3):	1,19 ±0,01
Range of temperature in dry atmospheric air (°C/°F):	-60° - +200°C / -140° - +392°
Compression set, DIN 53517, 24h/175°C (%):	Max. 25
Wear resistance:	Less suitable
Tear resistance:	Very good
Resistance to Weather and Ozone:	Excellent
Resistance to Hydrolysis (water and steam):	Good
Resistance to Chemicals (acids/bases):	Suitable
Resistance to mineral oil and gas:	Less suitable
Impermeability to air and gasses:	Not suitable

SERVICE LIFE

Average service life of a Silicone membrane is 2-3 months - actual life expectancy must be experimentally determined by the user.

Temp. max.:	121°C / 250°F
Steam pressure:	0 - 2 bar (g) / 0 - 29 psi (g)
Process pressure:	0 - 6 bar (g) / 0 - 87 psi (g)
CIP:	NaOH or similar
Samples:	1-5 a day

Net Weight

· Kg/lbs 0,030 kg / 0,06 lbs

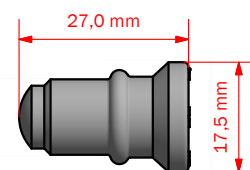
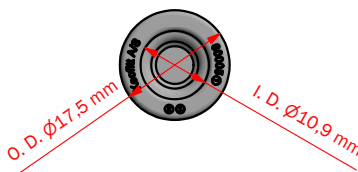
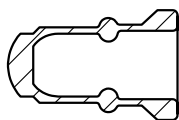

*For further information please visit keofitt.dk

Last updated 18-04-2016

For the newest datasheet please refer to keofitt.dk/images/pdf/datablade/600051.pdf

16.2 Silicone membrane for Micro Port - art. no. 600251



10 PC MEMBRANE W9/MP SILICONE GREY

ART. NO. 600251

GENERAL



KEOFITT has the widest selection of spare parts and accessories to complete your sampling system



Compatible with all KEOFIT W9 valve heads with micro port option



The patented membrane design is an essential part of the hygienic design of the KEOFIT sampling valves



It allows for optimal exposure to CIP and SIP media while also integrating the capacity to remove the membrane from the valve body without the use of tools

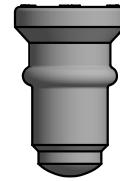

FEATURES



Compatible with all KEOFIT W9 valve heads with micro port option

CERTIFICATION*

FDA · USP · EU 1935/2004

TECHNICAL DATA

Type:	Silicone (QBF-65 - grey)
Hardness (°Sha):	70 ±3
Tensile strength (MPa):	Min. 8,5
Elongation at break (%):	550 ±80
Density (g/cm ³):	1,19 ±0,01
Range of temperature in dry atmospheric air (°C/°F):	-60° - +200°C / -140° - +392°
Compression set, DIN 53517, 24h/175°C (%):	Max. 25
Wear resistance:	Less suitable
Tear resistance:	Very good
Resistance to Weather and Ozone:	Excellent
Resistance to Hydrolysis (water and steam):	Good
Resistance to Chemicals (acids/bases):	Suitable
Resistance to mineral oil and gas:	Less suitable
Impermeability to air and gasses:	Not suitable

SERVICE LIFE

Average service life of a Silicone membrane is 2-3 months - actual life expectancy must be experimentally determined by the user.

Temp. max.:	121°C / 250°F
Steam pressure:	0 - 2 bar (g) / 0 - 29 psi (g)
Process pressure:	0 - 6 bar (g) / 0 - 87 psi (g)
CIP:	NaOH or similar
Samplex:	1-5 a day

Net Weight

· Kg/lbs	0,030 kg /0,07 lbs
----------	--------------------

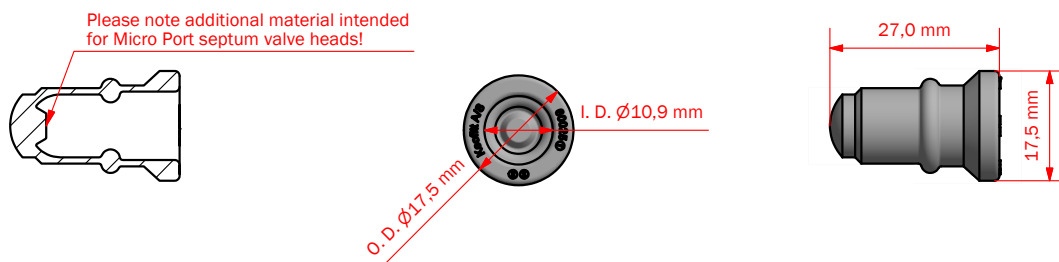

Please note additional material intended for Micro Port septum valve heads!

*For further information please visit keofitt.dk

Last updated 18-04-2016

For the newest datasheet please refer to keofitt.dk/images/pdf/datablade/600251.pdf

16.3 EPDM membrane - art. no. 600052



10 PC MEMBRANE W9/SIMPLEX EPDM BLACK

ART. NO. 600052

GENERAL



KEOFITT has the widest selection of spare parts and accessories to complete your sampling system



Compatible with all KEOFIT W9 & Simplex valve heads for silicone, EPDM & FFKM membrane



The patented membrane design is an essential part of the hygienic design of the KEOFIT sampling valves



It allows for optimal exposure to CIP and SIP media while also integrating the capacity to remove the membrane from the valve body without the use of tools



FEATURES



Compatible with all KEOFIT W9 & Simplex valve heads for silicone, EPDM & FFKM membrane

CERTIFICATION*

FDA · USP · EU 1935/2004

TECHNICAL DATA

Type:	EPDM (EPL-60 - black)
Hardness (°Sha):	61 ±3
Tensile strength (MPa):	Min. 16
Elongation at break (%):	400 ±50
Density (g/cm ³):	1,12 ±0,01
Range of temperature in dry atmospheric air (°C/°F):	-40° - +140°C / -40° - +284° F
Compression set, DIN 53517, 24h/175°C (%):	Max. 16
Wear resistance:	Very good
Tear resistance:	Very good
Resistance to Weather and Ozone:	Excellent
Resistance to Hydrolysis (water and steam):	Excellent
Resistance to Chemicals (acids/bases):	Very good
Resistance to mineral oil and gas:	Not suitable
Impermeability to air and gasses:	Less suitable

SERVICE LIFE

Average service life of an EPDM membrane is 2-3 months - actual life expectancy must be experimentally determined by the user.

Temp. max.:	121°C / 250°F
Steam pressure:	0 - 2 bar (g) / 0 - 29 psi (g)
Process pressure:	0 - 6 bar (g) / 0 - 87 psi (g)
CIP:	NaOH or similar
Samples:	1-5 a day

Net Weight

- Kg/lbs	0,040 kg /0,09 lbs
----------	--------------------

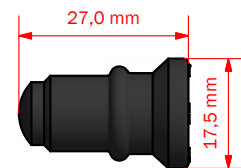
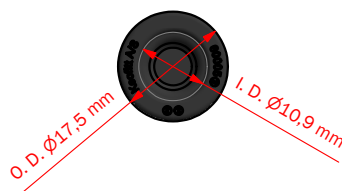
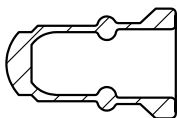

16.4 EPDM membrane for Micro Port - art. no. 600252



10 PACK MEMBRANE W9 EPDM, BLACK/MP

ART. NO. 600252

GENERAL



KEOFITT has the widest selection of spare parts and accessories to complete your sampling system



Compatible with all KEOFIT W9 valve heads with micro port option



The patented membrane design is an essential part of the hygienic design of the KEOFIT sampling valves



It allows for optimal exposure to CIP and SIP media while also integrating the capacity to remove the membrane from the valve body without the use of tools



FEATURES



Compatible with all KEOFIT W9 valve heads with micro port option

CERTIFICATION*

FDA · USP · EU 1935/2004

TECHNICAL DATA

Type:	EPDM (EPL-60 - black)
Hardness (°Sha):	61 ±3
Tensile strength (MPa):	Min. 16
Elongation at break (%):	400 ±50
Density (g/cm ³):	1,12 ±0,01
Range of temperature in dry atmospheric air (°C/°F):	-40° - +140°C / -40° - +284° F
Compression set, DIN 53517, 24h/175°C (%):	Min. 16
Wear resistance:	Very good
Tear resistance:	Very good
Resistance to Weather and Ozone:	Excellent
Resistance to Hydrolysis (water and steam):	Excellent
Resistance to Chemicals (acids/bases):	Very good
Resistance to mineral oil and gas:	Not suitable
Impermeability to air and gasses:	Less suitable

SERVICE LIFE

Average service life of an EPDM membrane is 2-3 months - actual life expectancy must be experimentally determined by the user.

Temp. max.:	121°C / 250°F
Steam pressure:	0 - 2 bar (g) / 0 - 29 psi (g)
Process pressure:	0 - 6 bar (g) / 0 - 87 psi (g)
CIP:	NaOH or similar
Samplex:	1-5 a day

Net Weight

- Kg/lbs	0,030 kg /0,07 lbs
----------	--------------------

Please note additional material intended for Micro Port septum valve heads!

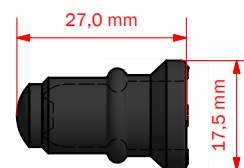
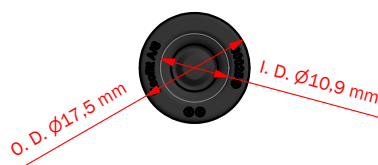
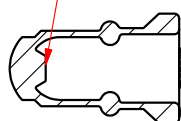

16.5 FFKM membrane - art. no. 600053



MEMBRANE W9 & SIMPLEX FFKM, WHITE

ART. NO. 600053

GENERAL



KEOFITT has the widest selection of spare parts and accessories to complete your sampling system



Compatible with all KEOFIT W9 & Simplex valve heads for silicone, EPDM & FFKM membrane



The patented membrane design is an essential part of the hygienic design of the KEOFIT sampling valves



It allows for optimal exposure to CIP and SIP media while also integrating the capacity to remove the membrane from the valve body without the use of tools

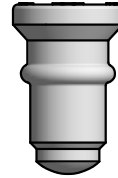

FEATURES



Compatible with all KEOFIT W9 & Simplex valve heads for silicone, EPDM & FFKM membrane

CERTIFICATION*

FDA · USP · EU 1935/2004

TECHNICAL DATA

Type:	FFKM (Perfluorelastomer)
Hardness (°Sha):	70 ±5
Tensile strength (MPa):	13
Elongation at break (%):	130
Density (g/cm ³):	2,41
Range of temperature in dry atmospheric air (°C/°F):	1° - +270°C / 34° - 518°F
Compression set, D395 70h/200°C (%):	24
Wear resistance:	Excellent
Tear resistance:	Excellent
Resistance to Weather and Ozone:	Excellent
Resistance to Hydrolysis (water and steam):	Excellent
Resistance to Chemicals (acids/bases):	Excellent
Resistance to mineral oil and gas:	Excellent
Impermeability to air and gasses:	Excellent

SERVICE LIFE

Average service life of a FFKM membrane is 12 months (or more) - actual life expectancy must be experimentally determined by the user.

Temp. max.:	250° C / 482° F
Steam pressure:	0 - 2 bar (g) / 0 - 29 psi (g)
Process pressure:	0 - 6 bar (g) / 0 - 87 psi (g)
CIP:	NaOH or similar
Samples:	1-5 a day

Net Weight

- Kg/lbs	0,004 kg / 0,009 lbs
----------	----------------------

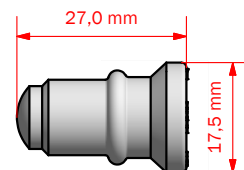
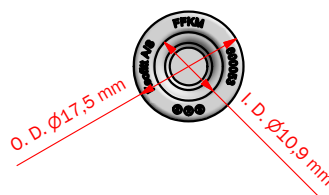
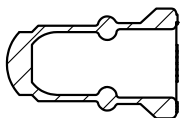

*For further information please visit keofitt.dk

Last updated 18-04-2016

16.6 PTFE membrane - art. no. 850055



MEMBRANE PTFE W9/SIMPLEX

ART. NO. 850055

GENERAL



KEOFITT has the widest selection of spare parts and accessories to complete your sampling system



Compatible with all KEOFIT W9 & Simplex valve heads for PTFE membrane



The patented membrane design is an essential part of the hygienic design of the KEOFIT sampling valves



It allows for optimal exposure to CIP and SIP media while also integrating the capacity to remove the membrane from the valve head without the use of tools

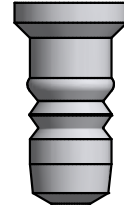

FEATURES



Compatible with all KEOFIT W9 & Simplex valve heads for PTFE membrane

CERTIFICATION*

- EU EC 1935/2004 · EU EC 2023/2006 · EU EC 10/2011 · DK No.822 06/2013 · FDA CFR 21 §177.1550 · USP Class VI
- REACH · RoHS · ADI Free · Keofitt DoC

TECHNICAL DATA

Type:	PTFE (TFM 1705 - white)
Tensile strength (psi):	4800
Elongation at break (%):	450
Density (g/cc):	2,16
Service Temperature Range (°C/°F):	-200 - +260 / -328 - +500
Deformation under Load (%):	
2175 psi - 24 h	9
2175 psi - 100 h	10
2175 psi - permanent	4,5
Flammability, UL94	V-0
Melt point, initial (°C):	342 ±10
Net weight (kg/lbs):	0,004 kg / 0,01 lbs

SERVICE TIME

Average service life of a PTFE membrane is 12 months, but depends very much on operating conditions and choice of cleaning method and sterilization - actual life expectancy must be experimentally determined by the user.

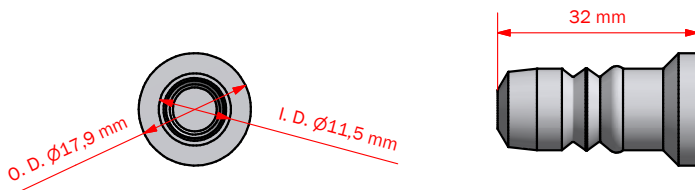

*For further information please visit keofitt.dk

Last updated 20-09-2017

16.7 Silicone membrane - art. no. 310051



10 PACK MEMBRANE I40 SILICONE

ART. NO. 310051

GENERAL



KEOFITT has the widest selection of spare parts and accessories to complete your sampling system



Compatible with all KEOFIT I40 valve heads with silicone & EPDM membrane



The patented membrane design is an essential part of the hygienic design of the KEOFIT sampling valves



It allows for optimal exposure to CIP and SIP media while also integrating the capacity to remove the membrane from the valve body without the use of tools

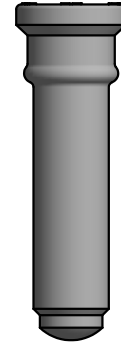

FEATURES



Compatible with all KEOFIT I40 valve heads with silicone & EPDM membrane

CERTIFICATION*

FDA · USP · EU 1935/2004

TECHNICAL DATA

Type:	Silicone (QBF-65 - grey)
Hardness (°Sha):	70 ±3
Tensile strength (MPa):	Min. 8,5
Elongation at break (%):	550 ±80
Density (g/cm3):	1,19 ±0,01
Range of temperature in dry atmospheric air (°C/°F):	-60° - +200°C / -140° - +392°
Compression set, DIN 53517, 24h/175°C (%):	Max. 25
Wear resistance:	Less suitable
Tear resistance:	Very good
Resistance to weather and ozone:	Excellent
Resistance to hydrolysis (water and steam):	Good
Resistance to chemicals (acids/bases):	Suitable
Resistance to mineral oil and gas:	Less suitable
Impermeability to air and gasses:	Not suitable

LIFE TIME

Average life time of a Silicone membrane is 2-3 months - to be determined by user.

SIP/CIP temp. max.:	121°C / 250°F
Steam pressure:	0 - 2 bar (g) / 0 - 29 psi (g)
Process pressure:	0 - 6 bar (g) / 0 - 87 psi (g)
CIP:	NaOH or similar

Net Weight

· Kg/lbs 0,040 kg /0,09 lbs

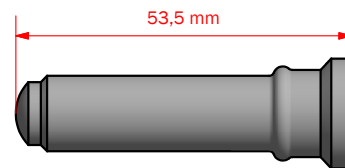
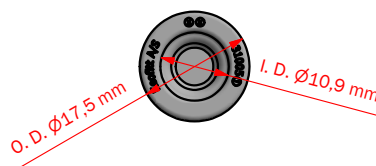
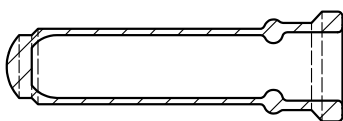

*For further information please visit keofitt.dk

Last updated 18-04-2016

16.8 EPDM membrane - art. no. 310052



10 PACK MEMBRANE I40 EPDM

ART. NO. 310052

GENERAL



KEOFITT has the widest selection of spare parts and accessories to complete your sampling system



Compatible with all KEOFIT I40 valve heads with silicone & EPDM membrane



The patented membrane design is an essential part of the hygienic design of the KEOFIT sampling valves



It allows for optimal exposure to CIP and SIP media while also integrating the capacity to remove the membrane from the valve body without the use of tools



FEATURES



Compatible with all KEOFIT I40 valve heads with silicone & EPDM membrane

CERTIFICATION*

FDA · USP · EU 1935/2004

TECHNICAL DATA

Type:	EPDM (EPL-60 - black)
Hardness (°Sha):	61 ±3
Tensile strength (MPa):	Min. 16
Elongation at break (%):	400 ±50
Density (g/cm ³):	1,12 ±0,01
Range of temperature in dry atmospheric air (°C/°F):	-40° - +140°C / -40° - +284° F
Compression set, DIN 53517, 24h/175°C (%):	Min. 16
Wear resistance:	Very good
Tear resistance:	Very good
Resistance to weather and ozone:	Excellent
Resistance to hydrolysis (water and steam):	Excellent
Resistance to chemicals (acids/bases):	Very good
Resistance to mineral oil and gas:	Not suitable
Impermeability to air and gasses:	Less suitable

LIFE TIME

Average life time of an EPDM membrane is 2-3 months - to be determined by user.

SIP/CIP temp. max.:	121°C / 250°F
Steam pressure:	0 - 2 bar (g) / 0 - 29 psi (g)
Process pressure:	0 - 6 bar (g) / 0 - 87 psi (g)
CIP:	NaOH or similar

Net Weight

· Kg/lbs 0,030 kg /0,07 lbs

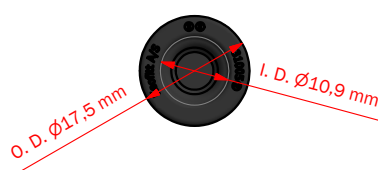
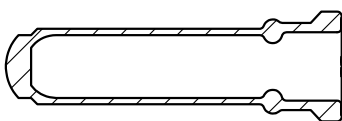

*For further information please visit keofitt.dk

Last updated 18-04-2016

16.9 PTFE membrane - art. no. 310055



MEMBRANE PTFE I40

ART. NO. 310055

GENERAL



KEOFITT has the widest selection of spare parts and accessories to complete your sampling system



Compatible with all KEOFIT I40 valve heads with PTFE membrane



The patented membrane design is an essential part of the hygienic design of the KEOFIT sampling valves



It allows for optimal exposure to CIP and SIP media while also integrating the capacity to remove the membrane from the valve head without the use of tools

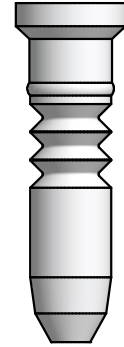

FEATURES



Compatible with all KEOFIT I40 valve heads with PTFE membrane

CERTIFICATION*

FDA CFR 21 §177.2600 · USP <88

TECHNICAL DATA

Material:	PTFE (AF 1610 - white)
Range of temperature in dry atmospheric air:	-200° - +200° C / -328° - +392°
Ball hardness (N/mm ²):	29
Tensile strength (DIN53455 - N/mm ²):	35
Elongation at break (DIN53455 - %):	350
Density (DIN 53479 - g/cm ³):	2,17
Shore D (DIN 53505):	57
Thermal conductivity (W/m.k DIN 52612):	0,22
Expansion coefficient (DIN 53752 [K ⁻¹]):	
Flammability:	Inflammable UL 94
Chemical resistance:	Is not attacked by common chemicals with the exception of strongly oxidising acids

LIFE TIME

Average life time of a PTFE membrane is 12 months - to be determined by user.

Temp. max.:	1 - 150° C / 34 - 302° F
Steam pressure:	0 - 2 bar (g) / 0 - 29 psi (g)
Process pressure:	0 - 6 bar (g) / 0 - 87 psi (g)
CIP:	NaOH <3% or similar

Net Weight

· Kg/lbs 0,008 kg / 0,02 lbs

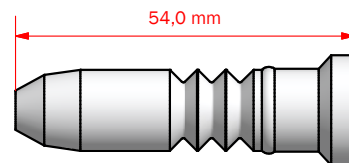
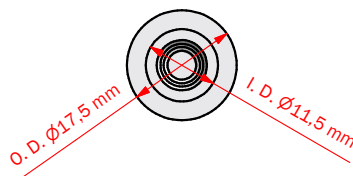
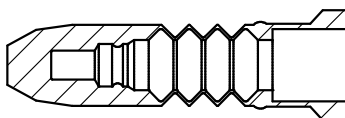

*For further information please visit keofitt.dk

Last updated 24-09-2014

16.10 Silicone membrane - art. no. 320051



10 PACK MEMBRANE I52 SILICONE

ART. NO. 320051

GENERAL



KEOFITT has the widest selection of spare parts and accessories to complete your sampling system



Compatible with all KEOFIT I52 valve heads with silicone & EPDM membrane



The patented membrane design is an essential part of the hygienic design of the KEOFIT sampling valves



It allows for optimal exposure to CIP and SIP media while also integrating the capacity to remove the membrane from the valve body without the use of tools

FEATURES



Compatible with all KEOFIT I52 valve heads with silicone & EPDM membrane

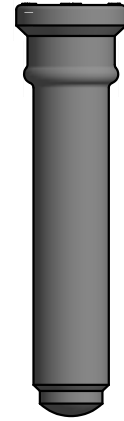

CERTIFICATION*

FDA · USP · EU 1935/2004

TECHNICAL DATA

Type:	Silicone (QBF-65 - grey)
Hardness (°Sha):	70 ±3
Tensile strength (MPa):	Min. 8,5
Elongation at break (%):	550 ±80
Density (g/cm3):	1,19 ±0,01

Range of temperature in dry atmospheric air (°C/°F): -60° - +200°C / -140° - +392°
Compression set, DIN 53517, 24h/175°C (%): Max. 25

Wear resistance:	Less suitable
Tear resistance:	Very good
Resistance to weather and ozone:	Excellent
Resistance to hydrolysis (water and steam):	Good
Resistance to chemicals (acids/bases):	Suitable
Resistance to mineral oil and gas:	Less suitable
Impermeability to air and gasses:	Not suitable

LIFE TIME

Average life time of a Silicone membrane is 2-3 months - to be determined by user.

SIP/CIP temp. max.:	121°C / 250°F
Steam pressure:	0 - 2 bar (g) / 0 - 29 psi (g)
Process pressure:	0 - 6 bar (g) / 0 - 87 psi (g)
CIP:	NaOH or similar

Net Weight

· Kg/lbs 0,040 kg /0,09 lbs

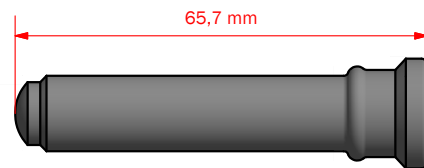
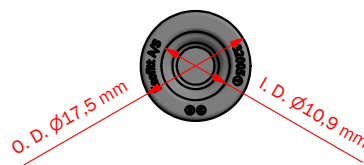
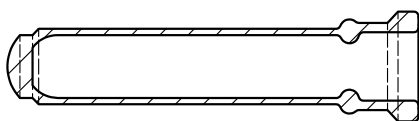

16.11 EPDM membrane - art. no. 320052



10 PACK MEMBRANE I52 EPDM

ART. NO. 320052

GENERAL



KEOFITT has the widest selection of spare parts and accessories to complete your sampling system



Compatible with all KEOFIT I52 valve heads with silicone & EPDM membrane



The patented membrane design is an essential part of the hygienic design of the KEOFIT sampling valves



It allows for optimal exposure to CIP and SIP media while also integrating the capacity to remove the membrane from the valve body without the use of tools

FEATURES



Compatible with all KEOFIT I52 valve heads with silicone & EPDM membrane



CERTIFICATION*

FDA · USP · EU 1935/2004

TECHNICAL DATA

Type:	EPDM (EPL-60 - black)
Hardness (°Sha):	61 ±3
Tensile strength (MPa):	Min. 16
Elongation at break (%):	400 ±50
Density (g/cm ³):	1,12 ±0,01
Range of temperature in dry atmospheric air (°C/°F):	-40° - +140°C / -40° - +284° F
Compression set, DIN 53517, 24h/175°C (%):	Min. 16
Wear resistance:	Very good
Tear resistance:	Very good
Resistance to weather and ozone:	Excellent
Resistance to hydrolysis (water and steam):	Excellent
Resistance to chemicals (acids/bases):	Very good
Resistance to mineral oil and gas:	Not suitable
Impermeability to air and gasses:	Less suitable

LIFE TIME

Average life time of an EPDM membrane is 2-3 months - to be determined by user.

SIP/CIP temp. max.:	121°C / 250°F
Steam pressure:	0 - 2 bar (g) / 0 - 29 psi (g)
Process pressure:	0 - 6 bar (g) / 0 - 87 psi (g)
CIP:	NaOH or similar

Net Weight

· Kg/lbs 0,040 kg /0,09 lbs

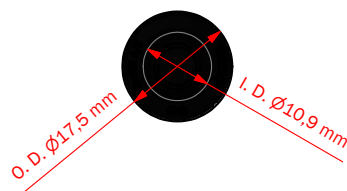
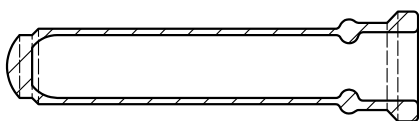

16.12 PTFE membrane - art. no. 320055



MEMBRANE I52 PTFE

ART. NO. 320055

GENERAL



KEOFITT has the widest selection of spare parts and accessories to complete your sampling system



Compatible with all KEOFIT I52 valve heads with PTFE membrane



The patented membrane design is an essential part of the hygienic design of the KEOFIT sampling valves



It allows for optimal exposure to CIP and SIP media while also integrating the capacity to remove the membrane from the valve body without the use of tools

FEATURES



Compatible with all KEOFIT I52 valve heads with PTFE membrane



CERTIFICATION*

FDA · USP · EU 1935/2004

TECHNICAL DATA

Material:	PTFE (TFM 1600 - white)
Range of temperature in dry atmospheric air:	-200° - +200° C / -328° - +392°
Ball hardness (N/mm ²):	29
Tensile strength (DIN53455 - N/mm ²):	35
Elongation at break (DIN53455 - %):	350
Density (DIN 53479 - g/cm ³):	2,17
Shore D (DIN 53505):	57
Thermal conductivity (W/m.k DIN 52612):	0,22
Expansion coefficient (DIN 53752 [K ⁻¹]):	12-17x10 ⁻⁵
Flammability:	Inflammable UL 94
Chemical resistance:	Is not attacked by common chemicals with the exception of strongly oxidising acids

LIFE TIME

Average life time of a PTFE membrane is 12 months - to be determined by user.

Temp. max.:	1 - 150° C / 34 - 302° F
Steam pressure:	0 - 2 bar (g) / 0 - 29 psi (g)
Process pressure:	0 - 6 bar (g) / 0 - 87 psi (g)
CIP:	NaOH or similar

Net Weight

· Kg/lbs 0,011 kg / 0,02 lbs

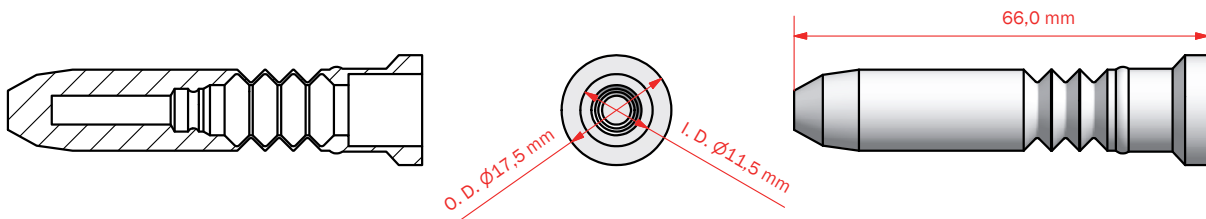

*For further information please visit keofitt.dk

Last updated 24-09-2014

Keofitt reserves the right to change technical data without notice!

For complete set of updated data sheets and manuals for Keofitt products please refer to our web page www.keofitt.dk



KEOFITT A/S
Kullinggade 31
DK-5700 Svendborg
Denmark

Phone +45 6316 7080
Fax +45 6316 7081

info@keofitt.dk
www.keofitt.dk



DON'T GAMBLE WITH YOUR SAMPLE™