



PRODUCT CATALOG 2022

Kullinggade 31
DK-5700 Svendborg
Denmark

Phone +45 6316 7080
www.keofitt.dk
www.samplingschool.com

DEAR CUSTOMER

We hope you will find this 2022 KEOFITT Product Catalog helpful identifying the right KEOFITT product for your sampling application. At KEOFITT we pride ourselves with the fact that “All we do is sampling!”. This is still true now more than 40 years after the company was founded.

Being the world market’s only true specialist KEOFITT has developed the widest and deepest product range available for hygienic, sterile and aseptic sampling of liquids in all industries.

Further information can be found at www.KEOFITT.dk or by contacting your local KEOFITT distributor.



KEOFITT SESAME

Taking the successful design of the classic KEOFITT valves to the third millennium: The patented KEOFITT SESAME™ is the only steam-sterilizable sampling valve in the world to completely eliminate the usually unavoidable dead-space involved with the steam-inlet connection.

This gives you:

- No open steam inlet while sampling: No risk of steam condensate or other leftovers secretly contaminating your sample.
- Minimal volume in valve chamber when sampling: Minimal sample size required.
- Unique, incorporated sterilization of the area behind the membrane and the seal between the valve head and the valve chamber: No risk of cross-contamination from the valve actuator area.
- Increased efficiency during sterilization due to steam flow angle: Optimal sterilization of valve seat in minimum time.
- Unique, incorporated CIP/SIP control valve: Eliminates need for additional control valve in most cases.
- Fully drainable even when positioned upside-down in the bottom of a tank: More than just the best-ever sampling valve design, this makes it the best designed bottom/harvest valve in the marketplace.



HOW IT WORKS

NORMAL POSITION

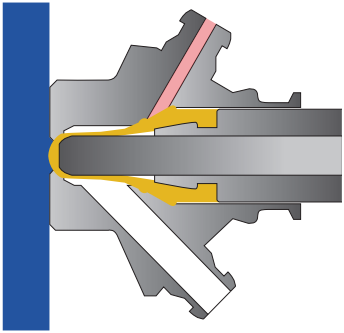

STEAM

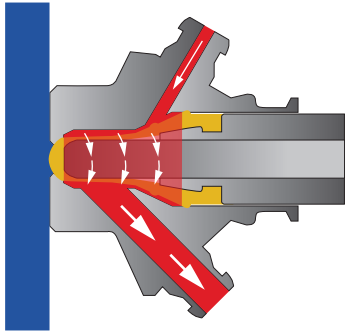

SAMPLE

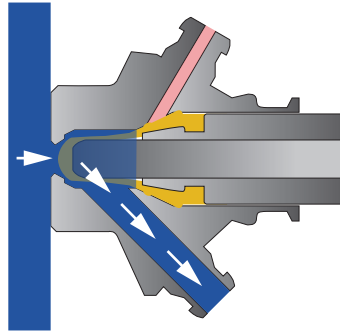

STEAM

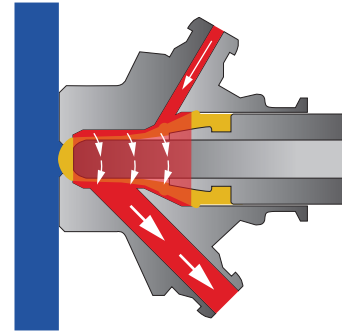

ADVANTAGES

1. Sample will never spray out through the steam inlet during sampling. With normal valves, this happens when the operator forgets to mount the cap or the cap disconnects.

2. It is not possible to unintentionally send steam or CiP fluids into the process line, as the sample seat and the steam seat cannot open simultaneously. This is a risk with all other valves as the steam inlet is open even during sampling.

3. Aseptic sampling in a closed system cannot be compromised in case the operator leaves the steam inlet open during sampling. Other valves will open for sampling even if steam inlet is open allowing airborne contamination of the sample.

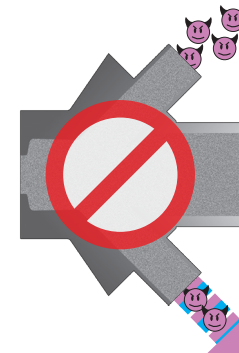
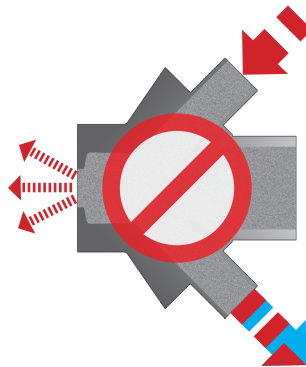
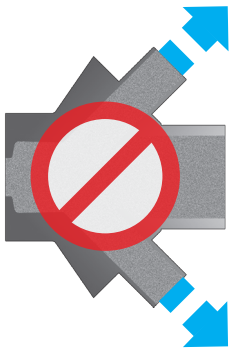

KEOFITT SESAME™ SAMPLING VALVE

The KEOFITT SESAME™ Sampling Valve is KEOFITT's newest and patented dual-seat sampling valve. Truly unique in the market, it offers optimal CIP and SIP conditions while also incorporating steam supply control and completely eliminating the steam inlet dead-space in other designs.



















The unique feature of this valve is in its membrane design which incorporates two separate seats for sampling and sterilizing/sanitizing, respectively. The second seat is located in the area sealing off the valve head. This design allows the sealing area to be sterilized along with the valve chamber prior to each sampling procedure. Furthermore, no separate inlet is required, thus eliminating any dead space while sampling.

The KEOFITT SESAME™ valve is designed for sampling of low or medium viscosity products in the range of 0-1,000 cP with particles less than 3 mm in diameter. Sampling of more viscous liquids is possible, only will it take longer (depending on process pressure). The double-seat SESAME™ valve is used in a range of applications such as brewery, dairy, pharmaceutical and biotechnological companies, with a wide range of products such as:

- Medical Solutions
- Filtered and Unfiltered Beer
- Creams and Lotions
- Unprocessed Milk
- Perfume











KEOFITT SESAME VALVE - BODIES







	WELDING BODIES			CONNECTION BODIES							INGOLD	
	TANK WELDING	PIPE WELDING	PIPE WELDING NW25	VARIVENT Ø50	VARIVENT Ø68	MINI CLAMP	CLAMP 1" & 1½"	CLAMP 2"	THREAD	UNION DIN 11851	INGOLD 40MM PORT LENGTH	INGOLD 52MM PORT LENGTH
HOSE PIECE	 890001	 890011	 890014	 890008	 890009	 890036	 NA-CONNECT ASME/DIN 890021	 890003	<i>on request</i>	 890040	<i>on request</i>	<i>on request</i>
1/2" TRI-CLAMP	 890006	 890010	<i>on request</i>	<i>on request</i>	 890013	 890039	 NA-CONNECT ASME/DIN 890022	 890005	<i>on request</i>	<i>on request</i>	 893105	 893205
THREAD M16X1,5	<i>on request</i>	<i>on request</i>	<i>on request</i>	<i>on request</i>	<i>on request</i>	<i>on request</i>	<i>on request</i>	<i>on request</i>	<i>on request</i>	<i>on request</i>	<i>on request</i>	<i>on request</i>
1/2" WELDING ENDS	 890007	 890019	<i>on request</i>	<i>on request</i>	<i>on request</i>	<i>on request</i>	<i>on request</i>	<i>on request</i>	<i>on request</i>	<i>on request</i>	<i>on request</i>	<i>on request</i>

SESAME BODIES











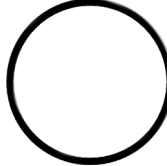
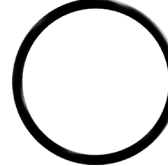

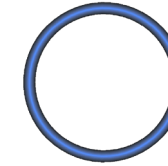

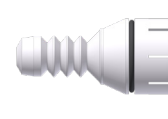





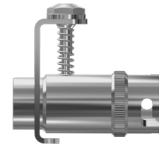

KEOFITT SESAME VALVE - HEADS

	TYPE H TURN KNOB 0-10 BAR	TYPE Q LEVER HANDLE 0-10 BAR	TYPE N PNEUMATIC 0-10 BAR
SILICONE	 890041	 890043	 890044
EPDM	 890041E	 890043E	 890044E
PTFE	 895541	 895543	 895544

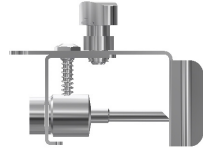

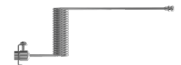
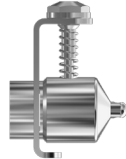
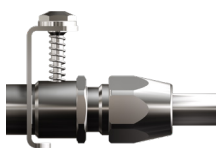
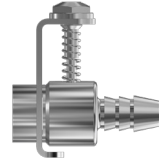
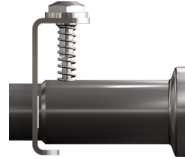
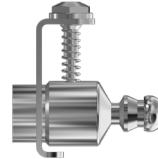

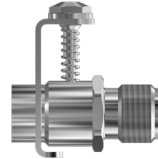

















KEOFITT SESAME INGOLD VALVE - HEADS

	TYPE H TURN KNOB 0-10 BAR	TYPE Q LEVER HANDLE 0-10 BAR	TYPE N PNEUMATIC 0-10 BAR
INGOLD I40 PTFE	 893141PTFE	 893143PTFE	 893144PTFE
INGOLD I52 PTFE	 893241PTFE	 893243PTFE	 893244PTFE

KEOFITT SESAME - PARTS & ACCESSORIES

SESAME PARTS & ACCESSORIES	O-RINGS	 300119 20.24X2.62 FDA	 400208 EPDM 60X3	 400308 EPDM 42X3	 550184 FESTO	 880830 EPDM 20.35X1.78			
	MEMBRANES	 890051 SILICONE	 890052 EPDM	 890055 PTFE	 895531 PTFE (I40)	 895532 PTFE (I52)			
	FOR VALVE HEADS	 600170 LEVER HANDLE N	 600370 LEVER HANDLE Q SELF-CLOSING	 880255 TOOL FOR PTFE	 890170 LEVER HANDLE Q	 890370 LEVER HANDLE Q SELF-CLOSING			
	FOR HOSE PIECE	 550002 PTFE QC 0.5M	 550003 PTFE QC 1.0M	 550057 KÄRCHER ADAPTER	 600062 RUBBER CAP	 800013 QC SPIKE	 800053 QC/QC W9	 800058 QC COIL	 800059 QC XL COIL
		 800061 QC PLUG	 800070 QC STEEL PIPE	 800082 QC HOSE BARB 3/8	 800083 QC TC	 800086 QC W9 WITH M4 HP	 800091 QC PTFE	 800171 QC ADAPTER HP/ THREAD	 900045 QC SYRINGE INJECTION

KEOFITT SESAME - PARTS & ACCESSORIES

FOR MINI TRI-CLAMP	 <p>300021 CLAMP PTFE 10/8</p>	 <p>550002.2 PTFE QC/TC 0.5M</p>	 <p>550003.2 PTFE QC/TC 1M</p>	 <p>550004 PTFE TC 0.5M</p>	 <p>550005 PTFE TC 1.0M</p>	 <p>800014 ADAPTER TC/1"</p>	 <p>900013 MINI CLAMP SPIKE</p>	 <p>900096 ADAPTER HP/TC</p>
	 <p>900097 ADAPTER M4 HP/TC</p>							
MISC.	 <p>700108 HP W9 F/WELDING</p>	 <p>800052 HP/HP W9</p>	 <p>900031 HP W9/ MALE THREAD M12X1</p>	 <p>890063 SINGLE ST. ST.</p>	 <p>890064 DOUBLE ST. ST. CHAIN</p>	 <p>900047 TUBE PTFE 10/8</p>		
	 <p>900074 GASKET EPDM 3/4"</p>	 <p>900087 GASKET EPDM 1/2"</p>	 <p>900091 GASKET EPDM 1"</p>	 <p>900092 GASKET EPDM 2"</p>	 <p>900075 CLAMP RING 1/2"</p>	 <p>900086 CLAMP RING 1"</p>	 <p>900189 CLAMP RING FOR SESAME VALVE</p>	 <p>900021 MINI BLIND CAP</p>

KEOFITT CLASSIC

Coaxial steam sterilizable design with separate inlet for SIP and CIP: The reference for hygienic and microbiological sampling for four decades, this is the original, in-situ sterilizable sampling valve that continues to revolutionize the field of sterile sampling.

Refined over the years - inside electro-polish being the latest addition - it remains the most popular and best selling valve in the market by far. It is based on KEOFITT's unique, patented membrane and is used in more than 300,000 sampling points worldwide.

Available in several models/sizes:

- W9 (ID 9 MM)
- INGOLD (ID 9 MM)
- 4KAI (ID 5 MM)
- W15 (ID 15MM)
- W25 (ID 25MM)



HOW IT WORKS

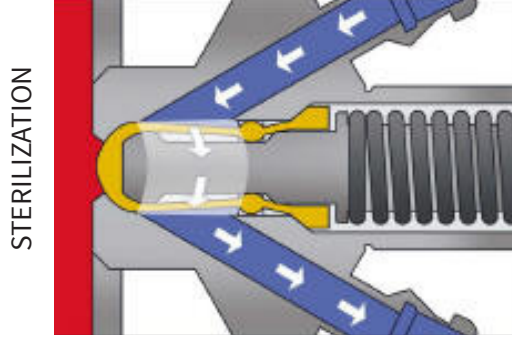
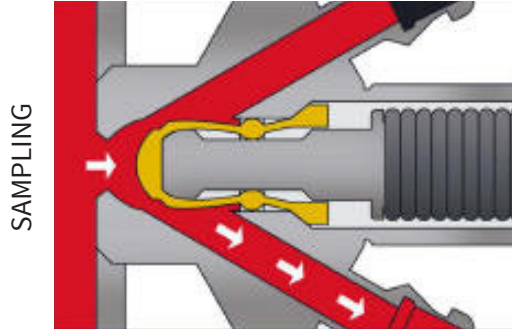

KEOFITT CLASSIC W9 SAMPLING VALVE

The KEOFITT CLASSIC W9 Sampling Valve is considered the father of all steam-sterilizable sampling valves. Refined through 40 years of experience it remains KEOFITT's most popular sampling valve. Designed for the sampling of medium viscosity products in the range of 0-1000 cP with particles less than 3 mm in diameter, it covers most needs for liquid sampling. Sampling of more viscous liquids is possible, only will it take longer (depending on process pressure).

This valve is used in a range of industries such as brewery, dairy, pharmaceutical and bio-tech for products such as:























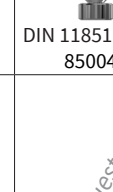



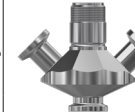

- Medical solutions
- Filtered Beer
- Creams and lotions
- Unprocessed milk

Besides the selection of the Valve Body and the Valve Head there are three different membrane materials to choose from: Silicone, EPDM and PTFE.

Accessories include quick couplings for the connection of tubing, piping and more.































KEOFITT CLASSIC W9™ SAMPLING VALVE - BODIES

	WELDING BODIES					CONNECTION BODIES						
	TANK WELDING	PIPE WELDING 1"	PIPE WELDING NW25	IN-LINE VERTICAL	IN-LINE HORIZONTAL	VARIVENT Ø50	VARIVENT Ø68	MINI CLAMP	CLAMP 1" & 1½"	CLAMP 2"	CLAMP 3"	THREAD M28X1,5
HOSE PIECE	 850001	 850011	 850014	 850027*	 850028*	 850008	 850009	 850036	 850021	 850003	 850004	 M28X1,5 850031
												 DIN 11851 DN 10 850040
½" TRI-CLAMP	 850006	 850010	<i>on request</i>	<i>on request</i>	<i>on request</i>	 850020	 850013	 850039	 850022  850025	 850005  850026	<i>on request</i>	<i>on request</i>
THREAD M16X1,5	 850015	 850016	 850018	<i>on request</i>	<i>on request</i>	<i>on request</i>	<i>on request</i>	<i>on request</i>	 850024	<i>on request</i>	<i>on request</i>	 850037
½" WELDING ENDS	 850007	 850019	<i>on request</i>	<i>on request</i>	<i>on request</i>	<i>on request</i>	<i>on request</i>	<i>on request</i>	<i>on request</i>	<i>on request</i>	<i>on request</i>	<i>on request</i>



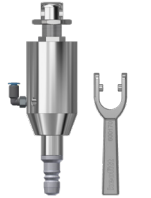







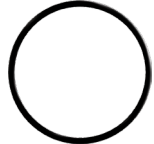
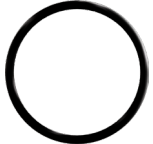







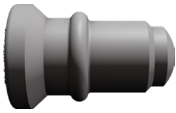

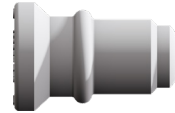

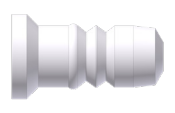

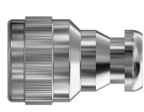





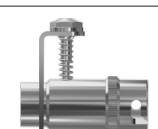

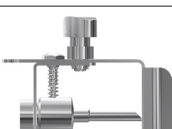



* ON REQUEST ONLY!

KEOFITT CLASSIC W9™ SAMPLING VALVE - HEADS

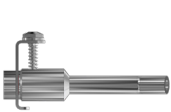

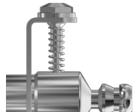
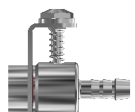

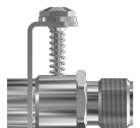
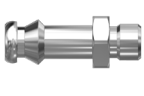

































	TYPE H TURN KNOB 0-10 BAR (FFKM 0-6 BAR)	TYPE H TURN KNOB W/ MICROPORT 0-10 BAR	TYPE K KEY RING 0-10 BAR (FFKM 0-6 BAR)	TYPE K KEY RING W/OPT. MICROPORT 0-10 BAR	TYPE Q LEVER HANDLE 0-10 BAR (FFKM 0-6 BAR)	TYPE N PNEUMATIC 0-10 BAR (FFKM 0-6 BAR)	TYPE N PNEUMATIC, ADJUSTABLE 0-10 BAR (FFKM 0-6 BAR)	TYPE B NO SPRING 0-12 BAR(G)
SILICONE	 600041	 600048	 600042	 600049	 600043	 600044	 600045	 600047
EPDM	 600041E	 600048E	 600042E	 600049E	 600043E	 600044E	 600045E	 600047E
FFKM	 600041F*	<i>on request</i>	 600042F*	<i>on request</i>	 600043F*	 600044F*	 600045F*	 600047F*
PTFE	 855541	<i>on request</i>	 855542	<i>on request</i>	 855543	 855544	 855545	 855547

W9™ HEADS

KEOFITT CLASSIC W9™ - PARTS & ACCESSORIES

W9™ PARTS & ACCESSORIES	O-RINGS	 400208 EPDM 60X3	 400308 EPDM 42X3	 550184 FESTO	 600825 SILICONE 7.1X1.6	 600825E EPDM 7.1X1.6	 800830 SILICONE 10.3X2.4	 800830E EPDM 10.3X2.4	 800859 SILICONE 7.5X2.5	 900829 EPDM 21X4
	MEMBRANES	 600051 SILICONE	 600052 EPDM	 600053 FFKM	 600251 SILICONE MP	 600252 EPDM MP	 850055 PTFE			
	FOR THREAD M16X1,5	 700061 STEEL CAP	 700062 HP W9 16X1.5	 700070 TUBE FITTING WL	 700071 TUBE FITTING PTFE	 700084 BARB 4MM	 700085 BARB 6MM			
	FOR HOSE PIECE	 550002 PTFE QC 0.5M	 550003 PTFE QC 1.0M	 550057 KÄRCHER ADAPTOR	 600062 RUBBER CAP	 800013 QC SPIKE	 800053 QC/QC W9	 800058 COIL	 800059 XL COIL	 800061 QC PLUG
		 800070 QC STEEL PIPE	 800082 QC HOSE BARB 3/8	 800083 QC TC	 800084 QC FOR CO2/O2 MEASUREMENTS	 800085 QC W9 MALE LUER LOCK	 800095 QC W9 FEMALE LUER LOCK	 800086 QC W9 WITH M4 HP	 800088 QC HOSE BARB Ø4	 800091 QC W/HOSE BARB FOR PTFE 10/8
		 800171 QC PTFE M16X1.5	 900031 HP MALE THREAD M12	 900045 QC SYRINGE INJECTION						

KEOFITT CLASSIC W9™ - PARTS & ACCESSORIES

W9™ PARTS & ACCESSORIES	FOR MINI TRI-CLAMP	 300021 CLAMP PTFE 10/8	 550004 PTFE TC 0.5M	 550005 PTFE TC 1.0M	 800014 ADAPTER TC/1"	 900013 MINI CLAMP SPIKE	 900096 ADAPTOR W9/W15 HP/TC	 900097 ADAPTER M4 HP/TC		
	FOR VALVE HEADS	 600076 KEY RING	 600149 BUSHING	 600255 TOOL PTFE	 900018 TOMMY BAR	 600170 LEVER HANDLE Q/N	 600370 LEVER HANDLE SELF-CLOSING			
	MISC.	 550002.2 PTFE QC/TC 0.5M	 550003.2 PTFE QC/TC 1.0M	 900047 TUBE PTFE 10/8	 600063 SINGLE ST. ST. CHAIN	 600064 DOUBLE ST. ST. CHAIN	 600066 SINGLE ST. ST. CHAIN W/HOOK	 400166 PROXIMITY SENSOR	 600266 PROXIMITY SENSOR	 600267 PROXIMITMOUNTING KIT
		 700108 HOSE PIECE	 800052 HOSE PIECE/ HOSE PIECE	 800075 WELDING PIECE FOR PTFE	 850840 PINOL SCREW	 900008 SOCKET ALU-TANKS	 900022 NEEDLE	 900069 WICK W9 VALVE MP	 900021 BLIND CAP	 900076 BLIND CAP 1"
		 900074 GASKET EPDM 3/4"	 900087 GASKET 1/2"	 900091 GASKET EPDM 1"	 900092 GASKET EPDM 2"	 900093 GASKET EPDM 3"	 900075 CLAMP RING 1/2"	 900086 CLAMP RING 1"	 900186 CLAMP RING 2"	

HOW IT WORKS

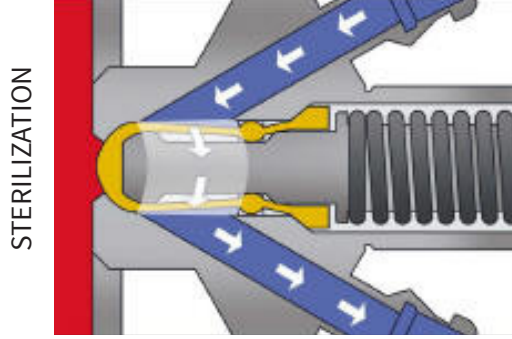
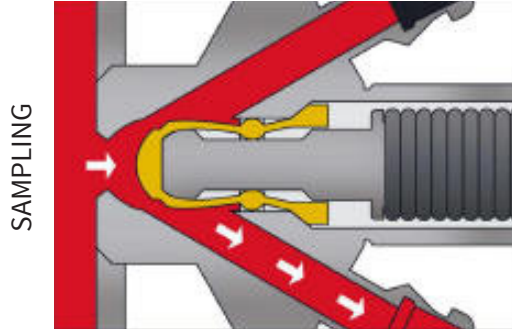

KEOFITT CLASSIC INGOLD SAMPLING VALVE

The KEOFITT CLASSIC INGOLD sampling valve is designed to fit bio-connectors type Ingold®. Designed for the sampling of medium viscosity products in the range of 0-1000 cP with particles less than 2 mm in diameter, it covers most needs for liquid sampling. Sampling of more viscous liquids is possible, only will it take longer (depending on process pressure).

This valve is used in a range of industries such as brewery, dairy, pharmaceutical and bio-tech for products such as:







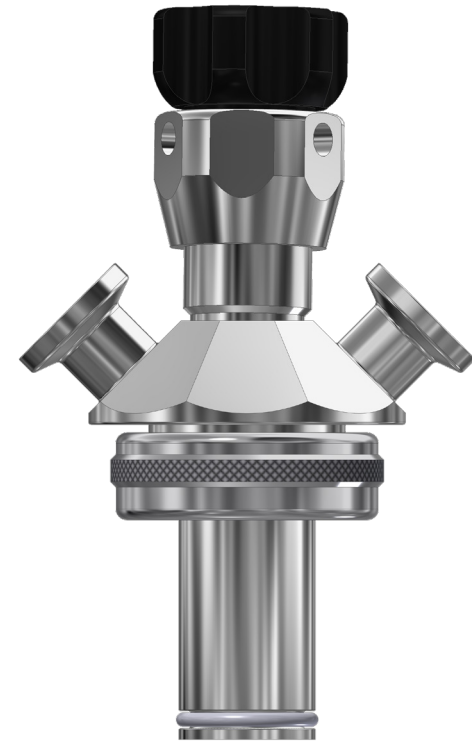















- Medical solutions
- Filtered Beer
- Creams and lotions
- Unprocessed milk

Besides the selection of the Valve Body and the Valve Head there are three different membrane materials to choose from: Silicone, EPDM and PTFE.

Accessories include quick couplings for the connection of tubing, piping and more.















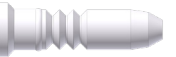



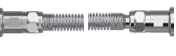
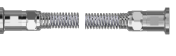















KEOFITT CLASSIC INGOLD SAMPLING VALVE - BODIES & HEADS

		STANDARD FOR 40 MM PORT LENGTH*		STANDARD FOR 52 MM PORT LENGTH*				TYPE H TURN KNOB 0-10 BAR(G)		TYPE Q LEVER HANDLE 0-10 BAR(G)		TYPE N LEVER HANDLE PNEUMATIC 0-10 BAR(G)		TYPE N PNEUMATIC, ADJUSTABLE 0-10 BAR	
		HOSE PIECE		MINI TRI-CLAMP				WELDING LINER		SILICONE		EPDM		PTFE	
INGOLD BODIES	HOSE PIECE	<i>on request</i>		<i>on request</i>		<i>on request</i>								<i>on request</i>	
	MINI TRI-CLAMP													<i>on request</i>	
	WELDING LINER	<i>on request</i>		<i>on request</i>											<i>on request</i>
								310041	320041	310043	320043	310044	320044		
								310041E	320041E	310043E	320043E	310044E	320044E		
								315541	325541	315543	325543	315544	325544		

* OTHER PORT LENGTH - AVAILABLE ON REQUEST

KEOFITT CLASSIC INGOLD - PARTS & ACCESSORIES

INGOLD - PARTS & ACCESSORIES	O-RINGS	 300118 EPDM 20.24X2.62	 300119 20.24X2.62 FDA	 550184 FESTO							
	MEMBRANES	 310051 SILICONE (I40)	 310052 EPDM (I40)	 310055 PTFE (I40)	 320051 SILICONE (I52)	 320052 EPDM (I52)	 320055 PTFE (I52)				
	FOR MINI TRI-CLAMP	 300021 CLAMP PTFE 10/8	 550004 PTFE TC 0.5M	 550005 PTFE TC 1.0M	 800014 ADAPTER MINI CLAMP/1" CLAMP	 800083 QC TC	 900013 MINI CLAMP SPIKE	 900096 ADAPTER HP/TC	 900097 ADAPTOR M4 HP/TC		
	VALVE HEADS	 300255 TOOL PTFE (I40/I52)	 550002.2 PTFE TUBING W/ QC/TC 0.5M	 550003.2 PTFE TUBING W/ QC/TC 1 M	 600149 BUSHING	 600170 LEVER HANDLE Q/N	 600370 LEVER HANDLE SELF-CLOSING	 850840 PINOL SCREW F/ W9 HEAD	 900018 TOMMY BAR	 900074 GASKET EPDM 3/4"	 900087 GASKET EPDM 1/2"
	MISC.	 320530 ADAPTOR 30MM (I52)V	 320540 ADAPTOR 40 MM (I52)	 320830 ADAPTOR PTFE 50MM (I52)	 400166 PROXIMITY SWITCH FOR M4/ W9	 600266 PROXIMITY SENSOR W9 CLOSED POS.	 600267 PROXIMITY SENSOR W9 MOUNTING KIT	 700108 HOSE PIECE W9	 900021 BLIND CAP FOR MINI CLAMP	 900075 CLAMP RING 1/2"	

HOW IT WORKS

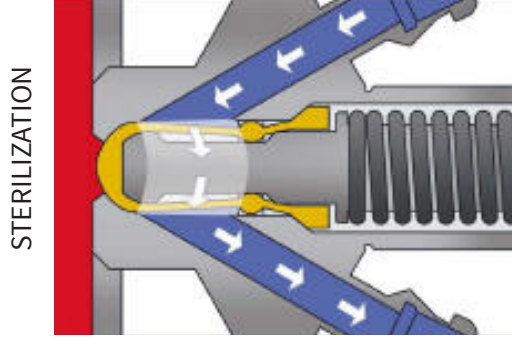
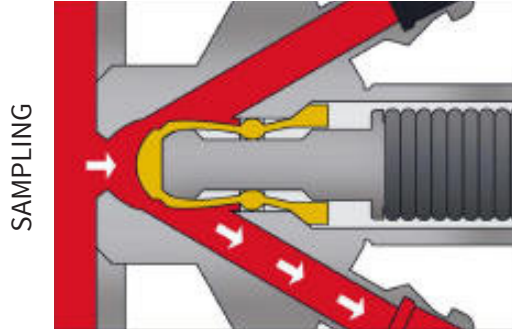

KEOFITT CLASSIC 4KAI SAMPLING VALVE

The KEOFITT CLASSIC 4KAI Sampling Valve is the smallest KEOFITT CLASSIC valve available. It is designed for the sampling of low viscosity products in the range of 0-100 cP with particles less than 1.5 mm in diameter. Sampling of more viscous liquids is possible, only will it take longer (depending on process pressure).

This valve is used in a range of industries such as brewery, dairy, pharmaceutical and bio-tech for products such as:



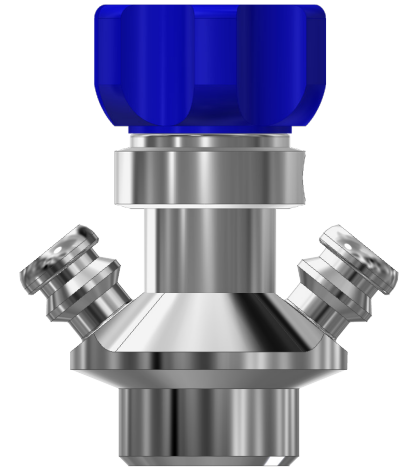

- Water
- Milk
- Medical solutions
- Filtered Beer
- Perfume
- Olive Oil

Besides the selection of the Valve Body and the Valve Head there are three different membrane materials to choose from: Silicone, EPDM and PTFE.









Accessories include quick couplings for the connection of tubing, piping and more.



















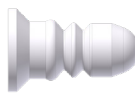

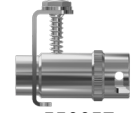



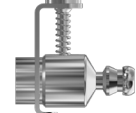
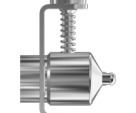
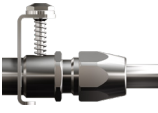

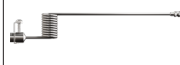





KEOFITT CLASSIC 4KAI VALVE - BODIES

	WELDING BODIES			CONNECTION BODIES	
	TANK WELDING	PIPE WELDING	PIPE WELDING NW25	MINI CLAMP	CLAMP 1" & 1½"
4KAI BODIES					
HOSE PIECE					
	440001	440011	440014	440021	440022

KEOFITT CLASSIC 4KAI VALVE - HEADS

	TYPE H TURN KNOB 0-10 BAR (G)	TYPE Q LEVER HANDLE 0-10 BAR (G)	TYPE N PNEUMATIC 0-10 BAR (G)
4KAI HEADS			
SILICONE			
	440041	440043	440044
EPDM			
	440041E	440043E	440044E
PTFE			
	445541	445543	445544

KEOFITT CLASSIC 4KAI - PARTS & ACCESSORIES

INGOLD - PARTS & ACCESSORIES	O-RINGS	 800830 10.3X2.4 SILIC	 800830E EPDM 10.3X2.4	 550184 FESTO	 600825 SILICONE 7.1X1.6						
	MEMBRANES	 400051 SILICONE	 400052 EPDM	 400055 PTFE							
	FOR HOSE PIECE	 550003 PTFE QC 1.0M	 550002 PTFE QC 0.5M	 550057 KÄRCHER ADAPTOR	 600062 RUBBER CAP	 800053 QC/QC W9	 800082 QC HOSE BARB 3/8	 800083 QC TC	 800086 QC W9 WITH M4 HP	 800061 QC PLUG	 800070 QC STEEL PIPE
		 900045 QC SYRINGE INJECTION	 900031 HP MALE THREAD M12	 800058 COIL	 800059 XL COIL	 800091 QC PTFE					
	VALVE HEADS	 900018 TOMMY BAR	 600370 LEVER HANDLE SELF-CLOSING	 600170 LEVER HANDLE Q/N	 400255 TOOL PTFE						
MISC.	 440064 DOUBLE ST. ST. CHAIN	 900086 CLAMP RING 1"	 900075 CLAMP RING 1/2"	 900047 TUBE PTFE 10/8	 900087 GASKET 1/2"	 900091 GASKET EPDM 1"	 550002.2 PTFE QC/TC 0.5M	 550003.2 PTFE QC/TC 1.0M	 440149 BUSHING FOR 4KAI/BASIX HEAD	 800052 HOSE PIECE/ HOSE PIECE	

HOW IT WORKS

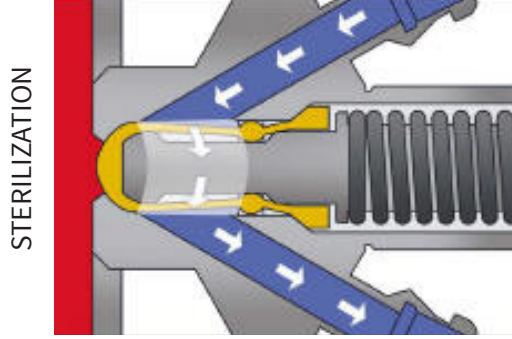
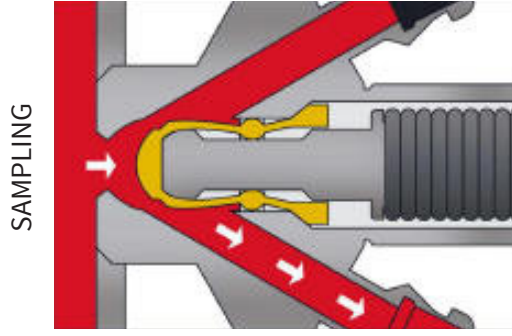

KEOFITT CLASSIC W15 SAMPLING VALVE

The KEOFITT CLASSIC W15 Sampling Valve is designed for high viscosity products in the range of 0-50,000 cP with particles up to 8 mm in diameter. Sampling of more viscous liquids is possible, only will it take longer (depending on process pressure).







This valve is used in a range of industries such as brewery, dairy, pharmaceutical and bio-tech for products such as:

- Yoghurt
- Honey
- Syrup
- Ketchup
- Marmalade
- Creams and lotions
- Fruit pulp products



Available with PTFE membrane.

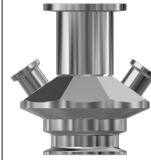











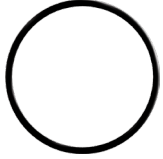

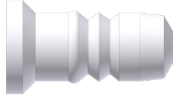



KEOFITT CLASSIC W15 VALVE - BODIES

	WELDING BODIES		CONNECTION BODIES			
	TANK WELDING	PIPE WELDING	VARIVENT Ø68	CLAMP 1"	CLAMP 2"	CLAMP 3"
W15 BODIES						
3/4" TRI-CLAMP						
	860001	860011	860009	860004	860002	860003
3/4" WELDING ENDS		<i>on request</i>	<i>on request</i>	<i>on request</i>	<i>on request</i>	<i>on request</i>
	860007					

KEOFITT CLASSIC W15 VALVE - HEADS

	TYPE H TURN KNOB 0-10 BAR (G)	TYPE B NO SPRING 0-12 BAR (G)	TYPE N PNEUMATIC 0-10 BAR
W15 HEADS			
PTFE			
	865541	865547	865544

KEOFITT CLASSIC W15 - PARTS & ACCESSORIES

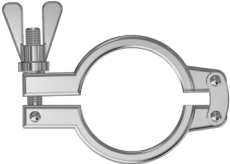
W15 PARTS & ACCESSORIES	O-RINGS	 400208 EPDM 60X3	 550184 FESTO				
	MEMBRANES	 860055 PTFE					
	FOR MINI TRI-CLAMP	 300021 CLAMP PTFE 10/8	 550004 PTFE TC 0.5M	 550005 PTFE TC 1.0M	 800014 ADAPTER TC/1"	 900013 MINI CLAMP SPIKE	 900096 ADAPTER HP/TC
	FOR VALVE HEADS	 600170 LEVER HANDLE Q/N	 600370 LEVER HANDLE SELF-CLOSING	 860255 TOOL PTFE			
	MISC.	 900021 BLIND CAP	 900074 GASKET EPDM 3/4"	 900092 GASKET EPDM 2"	 900093 GASKET EPDM 3"	 900075 CLAMP RING 1/2"	 900186 2" CLAMP RING

HOW IT WORKS

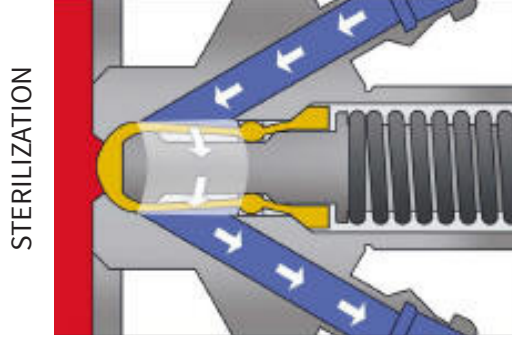
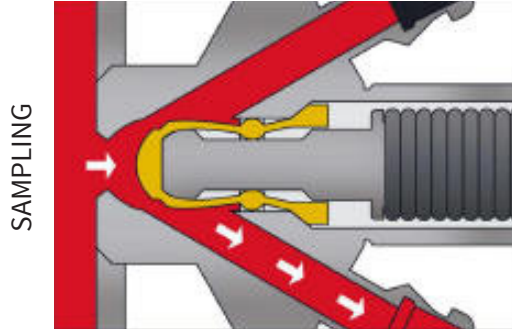

KEOFITT CLASSIC W25 SAMPLING VALVE

The KEOFITT CLASSIC W25 Sampling Valve is the largest KEOFITT sampling valve. Designed for sampling of very high viscosity products in the range of 0-250,000 cP and particles less than 17 mm in diameter. Sampling of more viscous liquids is possible, only will it take longer (depending on process pressure).



This valve is used in a range of industries such as food, dairy, pharmaceutical and bio-tech for products such as:

- Peanut Butter
- Fruit Pulp
- Syrup
- Cellulose
- Fruit Mixed Products
- Cosmetics

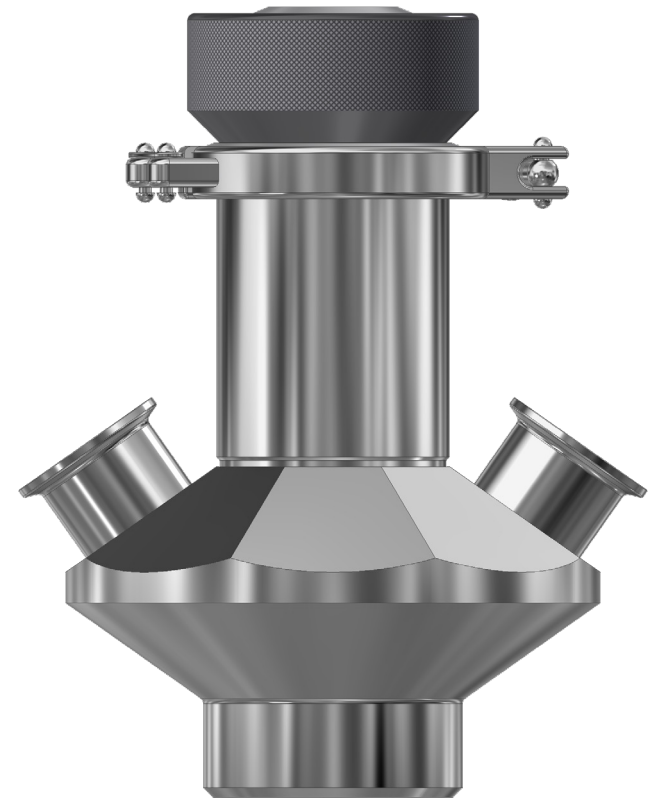
Available with PTFE membrane.



KEOFITT CLASSIC W25 VALVE - BODIES

	WELDING BODIES		CONNECTION BODIES	
	TANK WELDING	PIPE WELDING	VARIVENT Ø68	CLAMP 3"
1" CLAMP	 870001	<i>on request</i>	 870009	 870003
WELDING LINER	<i>on request</i>	<i>on request</i>	<i>on request</i>	<i>on request</i>







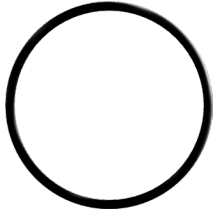

KEOFITT CLASSIC W25 VALVE - HEADS

	TYPE N LEVER HANDLE PNEUMATIC	TYPE B NO SPRING 0-12 BAR
PTFE	 875544	 875547

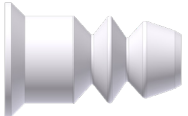
W25 BODIES

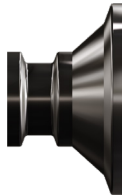
W25 HEADS

KEOFITT CLASSIC W25 - PARTS & ACCESSORIES

W25 PARTS & ACCESSORIES	O-RINGS	 400208 EPDM 60X3	 900091 GASKET EPDM 1"			
	MEMBRANES	 870055 PTFE				
	FOR VALVE HEADS	 870255 TOOL PTFE				
	MISC.	 800014 ADAPTER TC/1"	 900093 GASKET EPDM 3"	 900086 CLAMP RING 1"	 900187 CLAMP RING FOR W25 VALVE	

KEOFITT SINGLE-PORT SAMPLING VALVE

Replace your ordinary, non-hygienic sampling cocks with the KEOFITT Single-Port Sampling Valve.

This valve is CIP-able with process CIP and still true to the KEOFITT concept, as it is available with various process connections with manual or pneumatic operation.



HOW IT WORKS

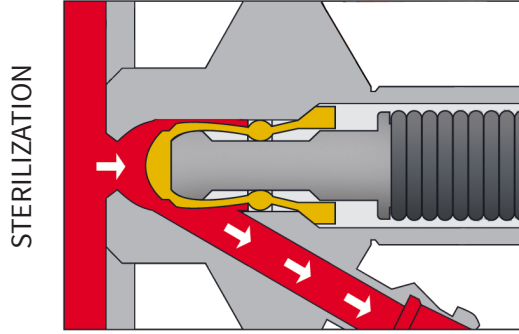
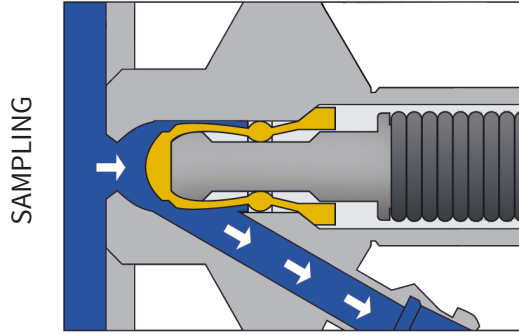

KEOFITT SINGLE-PORT W9™ SAMPLING VALVE

The KEOFITT Single-Port W9™ sampling valve is our solution for CIP-able sampling from less demanding applications. If the KEOFITT Single-Port sampling valve BASIX™ does not cover your need due its smaller size, the 9mm outlet on the Single-Port W9 will do the job. With the W9-solution you have the added benefit of choosing products from a selected range within the W9 product outline.

This valve is designed for sampling of products with a viscosity of 0-1000 cP with particles up to 3 mm in diameter.







The Single-Port W9 valve is usable for simple, hygienic sampling in all industries for products such as:

- Water
- Milk
- Perfume
- Fruit juice

Available in many versions; choose your preferred type of head from our W9 product outline.

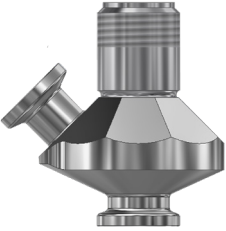

KEOFITT W9 SINGLE-PORT BODIES

W9 SINGLE-PORT BODIES	WELDING BODIES		CONNECTION BODIES			
	TANK WELDING	PIPE WELDING	VARIVENT Ø50	VARIVENT Ø68	MINI CLAMP	CLAMP 1" & 1½"
HOSE PIECE	 <p>850001-1</p>	 <p>850011-1</p>	 <p>850008-1</p>	 <p>850009-1</p>	 <p>850036-1</p>	 <p>850021-1</p>
½" TRI-CLAMP	<p><i>on request</i></p>	<p><i>on request</i></p>	<p><i>on request</i></p>	<p><i>on request</i></p>	 <p>850039-1</p>	<p><i>on request</i></p>

* CHOOSE VALVE HEAD AND PARTS & ACCESSORIES FROM THE W9 SECTION

HOW IT WORKS

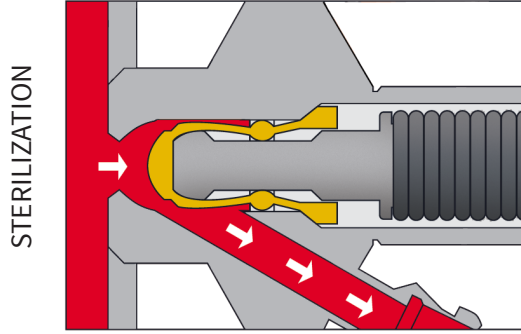
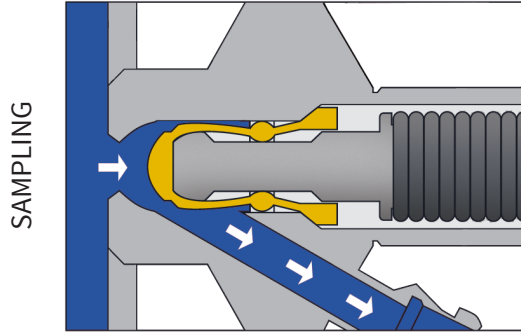

KEOFITT BASIX SAMPLING VALVE

The KEOFITT BASIX™ Sampling Valve is our basic CIP-able sampling valve for less demanding applications. The KEOFITT BASIX™ Sampling Valve is our product category for process CIP-able sampling valves for less demanding applications that require no separate inlet for sterilizing or sanitizing media.

This valve is designed for sampling of low viscosity products in the range of 0-100 cP with particles less than 1,5 mm in diameter.

Basix™ is used for simple, hygienic sampling in all industries for products such as:









- Water
- Milk
- Perfume
- Fruit Juice

Available in manual and pneumatic versions this valve is offered complete as a valve body and valve head combination.

















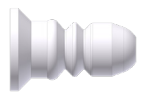









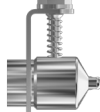



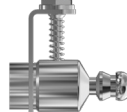



Choose from silicone, EPDM or PTFE membranes.



KEOFITT BASIX™ VALVES

	MANUAL VALVE				PNEUMATIC VALVE				
	TANK WELDING	PIPE WELDING	MINI CLAMP	1" & 1½" CLAMP	TANK WELDING	PIPE WELDING	MINI CLAMP	1" & 1½" CLAMP	
BASIX™ VALVES									
	SILICONE	450141	451141	452141	452241	450144	451144	452144	452244
	EPDM	450141EPDM	451141EPDM	452141EPDM	452241EPDM	450144EPDM	451144EPDM	452144EPDM	452244EPDM
PTFE	450141PTFE	451141PTFE	452141PTFE	452241PTFE	450144PTFE	451144PTFE	452144PTFE	452244PTFE	

KEOFITT BASIX™ - PARTS & ACCESSORIES

BASIX™ - PARTS & ACCESSORIES	O-RINGS	 550184 FESTO	 600825 SILICONE 7.1X1.6	 800830 SILICONE 10.3X2.4	 830830E EPDM 10.3X2.4				
	MEMBRANE	 400051 SILICONE	 400052 EPDM	 400055 PTFE					
	FOR HOSE PIECE	 450063 SINGLE ST.ST. CHAIN	 550002 PTFE QC 0.5M	 550003 PTFE QC 1.0M	 550002.2 PTFE QC/TC 0.5M	 550003.2 PTFE QC/TC 1M	 600062 RUBBER CAP	 800058 SAMPLING COIL W9	 800059 SAMPLING COIL XL W9
		 800053 QC/QC W9	 800061 QC PLUG	 800070 QC STEEL PIPE	 800082 QC W9 HOSE ID 7	 800083 QC TC	 800086 QC W9 WITH M4 HP	 800091 QC PTFE	 900045 QC SYRINGE INJECTION
	MISC.	 400255 TOOL FOR MEMBRANE (PTFE)	 440149 BUSHING FOR 4KAI/ BASIX HEAD	 600170 LEVER HANDLE Q/N	 600370 LEVER HANDLE SELF-CLOSING	 800052 HOSE PIECE/ HOSE PIECE W9	 900018 TOMMY BAR	 900031 HP W9/MALE THREAD M12	 900047 TUBE PTFE 10/8MM
		 900087 GASKET MINI CLAMP 1/2" EPDM	 900091 GASKET EPDM 1"	 900075 CLAMP RING 1/2"	 900086 CLAMP RING 1"				

KEOFITT SAMPLING BAGS



This is where you find everything you need to complete your KEOFITT sampling system:

The main products for this category is the unique single-use sampling bag systems allowing safe and aseptic sampling from any type of sampling valve. You can improve sample integrity and convenience immediately by using these products for existing sampling devices – whether they are KEOFITT or not.

The KEOFITT Sampling Bags have all been developed as single-use solutions to the cumbersome and difficult task of taking a representative sample and bringing it safe and clean from the sampling point to the laboratory.

At the same time the KEOFITT Sampling Bags offer convenience and safety in use and higher efficiency in the work process. No prior assembly or cleaning of any components; no glass or metal component is introduced to the production area.

All KEOFITT Sampling Bags are made of medical grade plastics complying with all relevant FDA, USP and ISO regulations for both the food and the pharmaceutical/biotech industries.

The KEOFITT Sampling Bags are delivered separately packed and sterilized by irradiation. In each carton a Radiation Certificate and a Certificate of Conformity are enclosed.

The KEOFITT Sampling Bags are manufactured following strict in-process testing including a test for endotoxins.

The proper performance of all KEOFITT Sampling Bags is supported by a number of validation documents covering SIP'ability, biocompatibility, extractables, USP Class VI, endotoxins, mechanical and chemical properties etc.



KEOFITT SAMPLING BAG™

The brand new single-use KEOFITT Sampling Bag™ is designed to collect liquid process samples in a hygienic, safe and efficient way.

The KEOFITT Sampling Bag™ is suitable for any liquids with very high viscosity in the range of 0-250,000 cP and liquid products with solid particles with a size of up to 15mm in diameter.

Its unique and certified design allows an effective sterilization or disinfection of the complete flow prior to sampling to ensure the integrity of the sample.

The samples will be protected from any air-borne or cross contamination, as they are taken into a closed and hygienic system.

The KEOFITT Sampling Bag™ fits ALL KEOFITT valves - including W15 and W25 valves.

Intended for collecting and storing any samples for microbiological and chemical/physical analysis, it is an ideal solution for food/dairy/beverage/brewing applications.



HOW IT WORKS

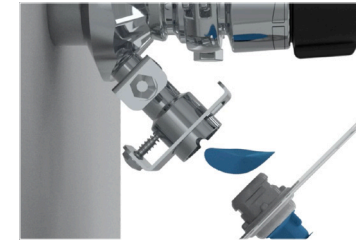

Remove the seal from the inlet and outlet and connect the bag to the valve by using the corresponding fitting.



Clean/sterilize the flow path (valve and bag) through the valve inlet.

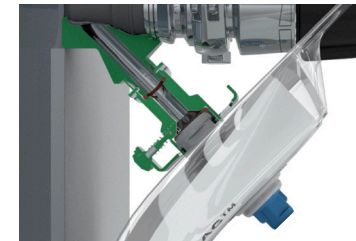

Open the bag and the sampling valve to take the sample.

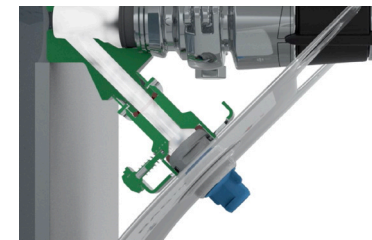

Close the valve and the bag (optional: flush/clean/sterilize again)



Remove the bag and bring it to the lab for analyzing the sample.

KEOFITT SAMPLING BAG™

KEOFITT SAMPLING BAG™	KEOFITT SAMPLING BAG™	
	SIZE	ART.NO.
	1000 ML	151000
2000 ML	152000	

PARTS & ACCESSORIES

KEOFITT SAMPLING BAG™ PARTS & ACCESSORIES	FOR KSB INLET	FOR KSB OUTLET
	150083 QUICK COUPLING KSB INLET FOR HOSE PIECE	150061 QUICK COUPLING KSB OUTLET STAINLESS STEEL PLUG
	150085 QUICK COUPLING KSB INLET 1" CLAMP	150082 QUICK COUPLING KSB OUTLET 3/8" HOSE BARB (CLOSABLE)
150088 QUICK COUPLING KSB INLET 1/2" CLAMP		
150084 QUICK COUPLING KSB INLET 3/4" CLAMP		
150062 QUICK COUPLING KSB INLET STAINLESS STEEL PLUG		

KEOFITT STERILE SAMPLING BAGS

The KEOFITT Sterile Sampling Bag is a sterile, pre-irradiated sampling bag wrapped in a sealed PE-bag. The sterile condition and the closed fluid path enables the user to extract liquid samples from the process line greatly reducing the risk of contaminating the sample from airborne contaminants in the environment compared to using traditional sample recipients.

The KEOFITT Sterile Sampling Bag is the ultimate sampling bag solution based on KEOFITT's renowned high quality and ultra hygienic sampling valve design. It is delivered with either a Mini Tri-Clamp or a KEOFITT W9 Quick Coupling.

The Sterile Sampling Bag is intended for collecting and easy storage of samples for chemical analysis. For microbiological samples the Aseptic Sampling Bag is recommended.

The product to be sampled should have a maximum viscosity of 1000 cP and should not contain particles larger than 3 mm in diameter. Products with higher viscosity may be sampled, only will it take longer.

The KEOFITT Sampling Bag is foreseen with a secondary port with a septum for extracting a sample of the sample or for injecting a substance into the sample. The secondary port also fitted with Luer Lock fittings (male and female) for secure and sterile connection to relevant equipment in a Laminar Air Flow (LAF) bench.



HOW IT WORKS

KEOFITT® STERILE SAMPLING BAG

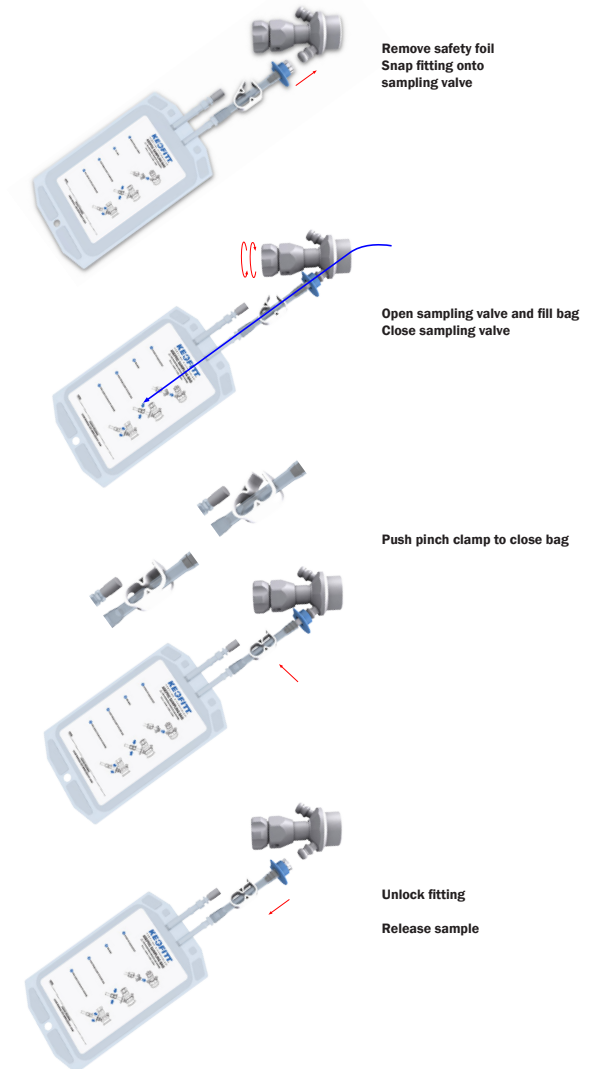

KEOFITT STERILE SAMPLING BAGS

STERILE SAMPLING BAGS

	SIZE	ART. NO.
	1000 ML	111000
	2000 ML	112000*

KEOFITT STERILE SAMPLING BAGS

HOSE PIECE



* ON REQUEST ONLY!

KEOFITT ASEPTIC SAMPLING BAGS

The KEOFITT Aseptic Sampling Bag is a sterile, pre-irradiated sampling bag wrapped in a sealed PE-bag. Contrary to the Sterile Sampling Bag the Aseptic Bag is equipped with a 3-way valve allowing to steam sterilize the bag system before sampling. The sterile condition and this possibility to steam the flowpath in a closed circuit enable the user to extract a truly representative aseptic sample from a liquid process line sampling point in a convenient way.

The KEOFITT Aseptic Sampling Bag is the ultimate sampling bag solution based on KEOFITT's renowned high quality and ultra hygienic sampling valve design. The unique design allows the connection between the sampling valve and the sampling bag to be steam sterilized in place. It is delivered with either a Mini Sanitary Clamp or a KEOFITT W9 Quick Coupling.

The Aseptic Sampling Bag is a single use product intended for collecting and easy storage of samples from true aseptic samples for microbiological and chemical analysis.

The product to be sampled should have a maximum viscosity of 1000 cP and should not contain particles larg Laminar Air Flow (LAF) bench.

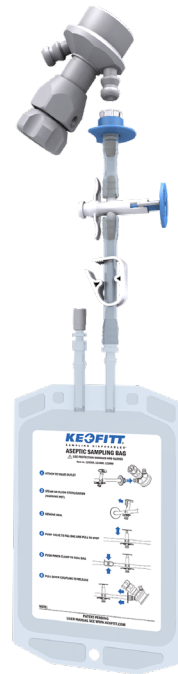

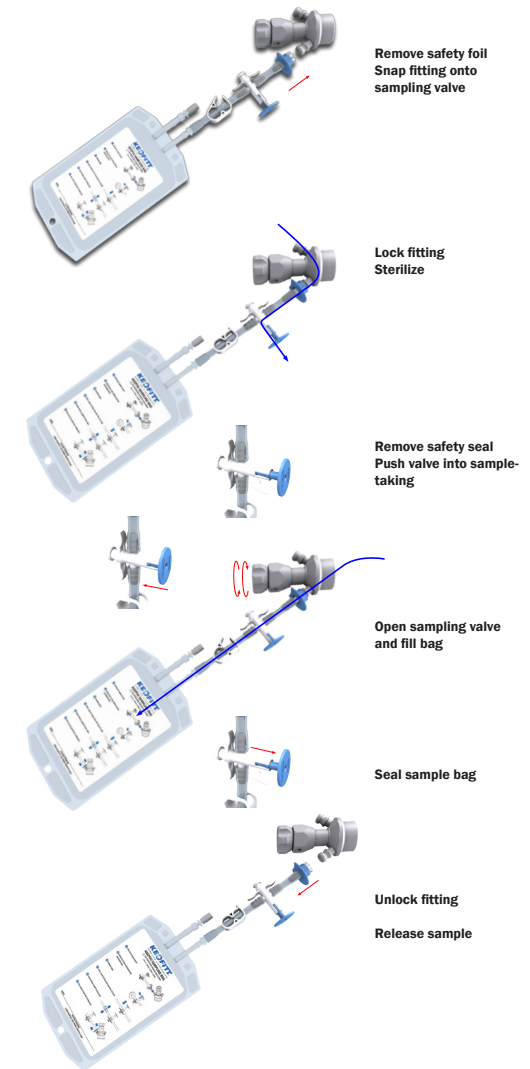

HOW IT WORKS

KEOFITT® ASEPTIC SAMPLING BAG



KEOFITT ASEPTIC SAMPLING BAGS

		ASEPTIC SAMPLING BAGS	
		SIZE	ART. NO.
HOSE PIECE		250ML	120250
		500 ML	120500
		1000 ML	121000
		2000 ML	122000
MINI TRI-CLAMP		500 ML	120500TC
		2000 ML	122000TC

KEOFITT SPIKE SAMPLING BAGS

The KEOFITT Spike Sampling Bag is a cost-effective single-use sampling bag to be used where requirements to sterility and storage time are less severe. It features a unique auto-sealing septum allowing very thick needles for fast and convenient sampling of most liquids including viscous products.

The KEOFITT Spike Sampling Bag is a single-layer sampling bag manufactured under cleanroom conditions (class D) and available in:

- A polypropylene (PP) bag where cleanroom manufacturing conditions are sufficient

The Spike Sampling Bag features a unique sealed and sterilized septum, which accepts very large needles (spikes) with 2-3 mm internal diameter. This assures a much faster sampling process than otherwise experienced with hypodermic needles. Despite the large needle the unique septum design assures an auto-sealing effect after collection of the sample.

The Spike Sampling Bag works with the KEOFITT Quick Coupling Spikes that fit all standard Simplex, M4 and W9 KEOFITT Sampling valves with either KEOFITT Hose Piece connection or Mini Clamp connection (see Accessories).



KEOFITT SPIKE SAMPLING BAGS

SPIKE BAGS

SIZE

ART. NO.

1000 ML

131000PP



KEOFITT SAMPLING BAGS

KEOFITT SAMPLING BAGS - PARTS & ACCESSORIES

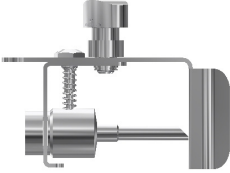
W25 PARTS & ACCESSORIES	FOR HOSE PIECE	 <p>400830 SILICONE 5.3X2.4</p>	 <p>800830 SILICONE 10.3X2.4</p>	 <p>800013 QC SPIKE (W9)</p>			
	FOR MINI TRI-CLAMP	 <p>900013 MINI CLAMP SPIKE</p>	 <p>800014 ADAPTOR TC/1"</p>	 <p>800083 QC W9/TC</p>	 <p>900096 ADAPTOR W9/W15 HP/TC</p>	 <p>900075 CLAMP RING 1/2"</p>	
		 <p>900087 GASKET EPDM 1/2"</p>	 <p>900074 GASKET EPDM 3/4"</p>				

SAMPLING

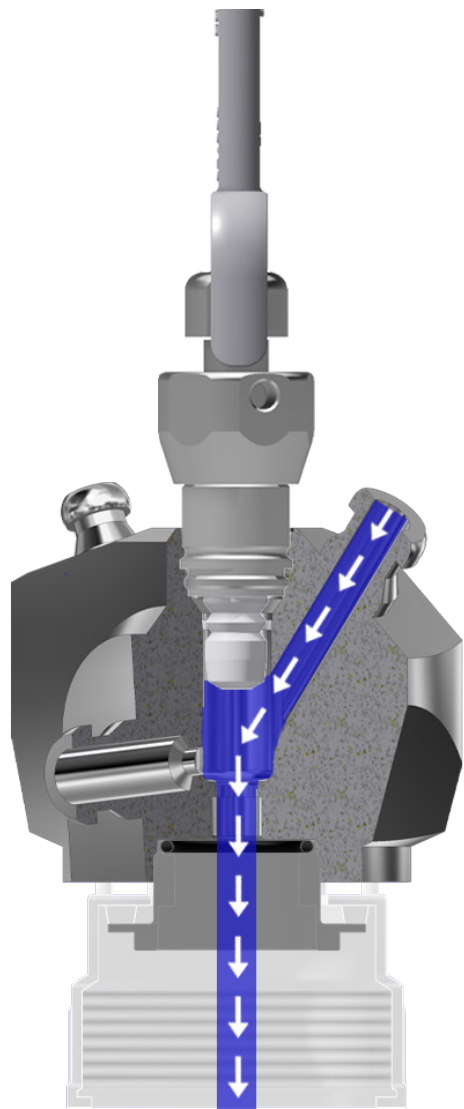

STERILIZATION

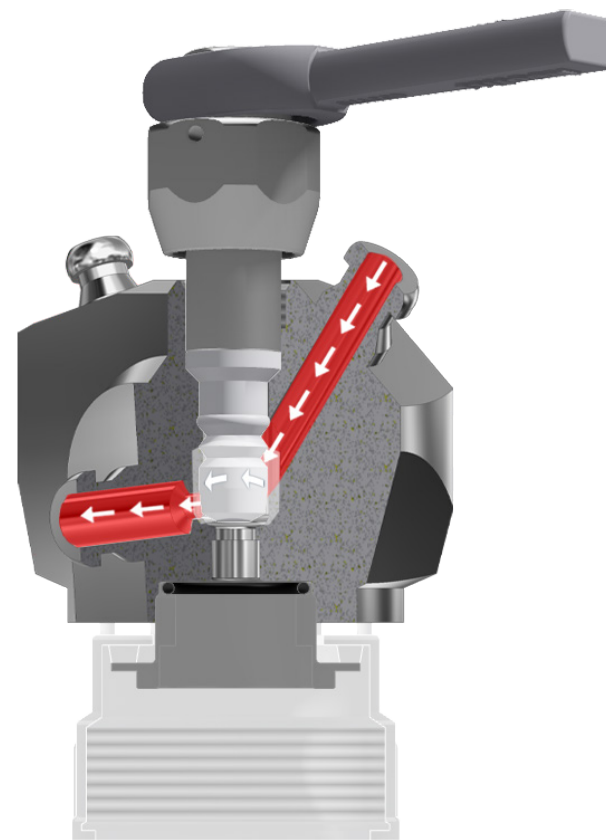

KEOFITT BOTTLE SAMPLING SYSTEMS





The KEOFITT Aseptic System enables the user to take a truly representative aseptic sample. It protects the sample against airborne contamination, while extracting the sample, during transportation and storage.

The standard operating procedure involves steaming the sampling valve with the KEOFITT Aseptic System connected, in order to sterilize the sampling valve and the connection between the sampling valve and the KEOFITT Aseptic System. This procedure ensures the sterilization of the whole flow path in a closed circuit.































The KEOFITT Aseptic System is based on KEOFITT's guaranteed high quality, microbiologically safe valve design. It shall be used with PP sampling bottles (# 260325 / 260525 / 260625 / 260725 / 260825), which are autoclavable, robust and translucent.

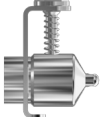

KEOFITT SAMPLING BOTTLE SYSTEMS

SAMPLING BOTTLE SYSTEMS	ASEPTIC SAMPLING SYSTEM FOR BOTTLE SIZES 250-2000ML	ASEPTIC SAMPLING SYSTEM FOR BOTTLE SIZES 4000/5000ML	SAMPLING BOTTLE HEAD W9	SAMPLING BOTTLE HEAD W15	SAMPLING BOTTLE HEAD W25
	 <p data-bbox="309 1444 392 1476">260005</p>	 <p data-bbox="705 1444 788 1476">260006</p>	 <p data-bbox="1108 1444 1191 1476">260030</p>	 <p data-bbox="1512 1444 1594 1476">860030</p>	 <p data-bbox="1915 1444 1998 1476">870030</p>

KEOFITT SAMPLING BOTTLES - PARTS & ACCESSORIES

SAMPLING BOTTLES - PARTS & ACCESSORIES	BOTTLES	 260325 PP BOTTLE 250ML	 260525 PP BOTTLE 1000ML	 260625 PP BOTTLE 2000ML	 260725 PP BOTTLE 4000ML	 260825 PP BOTTLE 5000ML				
	TUBINGS	 550002 PTFE QC 0.5M	 550002.2 PTFE QC/TC 0.5M	 550003 PTFE QC 1.0M	 550003.2 PTFE QC/TC 1M	 550004 PTFE TC 0.5M	 550005 PTFE TC 1.0			
	MISC.	 260327 GASKET PP 250-2000 ML	 260427 GASKET PP 4000/5000 ML	 260326 LID PP BOTTLE W/HOLE 250-2000 ML	 260328 LID PP BOTTLE 250-2000 ML	 260426 LID PP BOTTLE W/ HOLE 4000/5000 ML	 260428 LID PP BOTTLE 4000/5000 ML	 260081 QC F/FILTER ASEPTIC SYSTEM	 260122 STERILE FILTER FOR ASEPTIC SYSTEM	
		 260158 O-RING EPDM 21.89X2.62	 260159 O-RING EPDM 24.6X2.4	 800014 ADAPTER TC/1"	 800053 QC/QC W9	 800061 QC W9 ST. ST. PLUG	 900096 ADAPTER HP/TC	 900097 ADAPTER HP/TC	 900021 BLIND CAP MINI CLAMP	 900076 BLIND CAP 1" CLAMP
		 900074 GASKET EPDM 3/4"	 900091 GASKET EPDM 1"	 900075 CLAMP RING 1/2"	 900086 CLAMP RING 1"					

KEOFITT VARIOUS

Being the world market's only true specialist KEOFITT has developed the widest and deepest product range available for sampling of liquids in all industries.

To satisfy the specific demands from the different industries KEOFITT has introduced a various special items, such as:

- **Micro Port**
provide an easy and hygienic solution for extracting liquid samples from a production batch using hypodermic needles or syringes.
- **Portable Steam Cleaning Unit**
designed to provide steam for cleaning and disinfecting in sampling locations where a fixed steam supply is not available.
- **Carlsberg Flask vessel system**
designed for the propagation of yeast cultures in a sterile environment and the transfer of the pure yeast culture under sterile conditions.



HOW IT WORKS

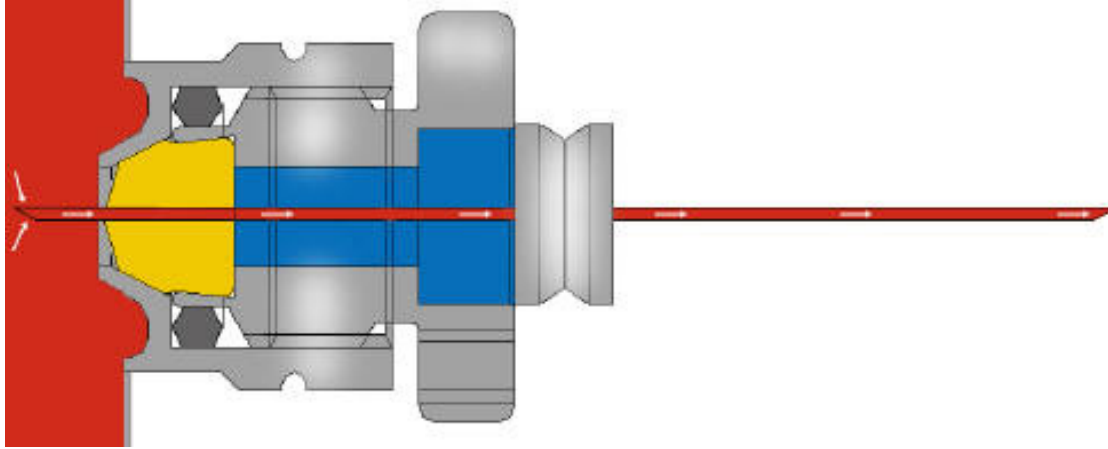

KEOFITT MICRO PORT

The KEOFITT MICRO PORT is a re-sealing rubber septum designed to take samples using hypodermic needles or syringes with minimal risk of contamination. Designed for sampling low viscosity products in the range 0-50 cP.

The KEOFITT MICRO PORT is easy to use and maintain, if needle sampling is required.











The Micro Ports are used in a range of business areas, such as brewery, dairy, pharmaceutical and biotechnological industries, with a wide range of products such as:

- Water
- Medical solutions
- Milk
- Filtered Beer
- Perfume
- Olive Oil











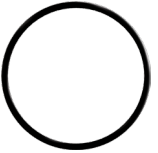









Available as a single septum or as a MULTI MICRO PORT with seven septums.



KEOFITT MICRO PORT

		MICRO PORT			MULTI MICRO PORT 49		
		TANK	PIPE WELDING 1"	PIPE WELDING NW25	TANK WELDING 7 X BUTYL MEMBRANE	VARIVENT Ø68 7 X BUTYL MEMBRANE	CLAMP 3" 7 X BUTYL MEMBRANE
MICRO PORT / MULTI MICRO PORT 49 BUTYL (IIR) MEMBRANE		 900056	 900057	 900014			
		VARIVENT Ø31	VARIVENT Ø50	VARIVENT Ø68			
		 900026	 900027	 900028			
		MINI CLAMP	CLAMP 1" & 1 1/2"				
		 900059	 900058		840001	840009	840020

KEOFITT MICRO PORT - PARTS & ACCESSORIES

MICRO PORT PARTS & ACCESSORIES	O-RINGS								
		400208 EPDM 60X3	900822 EPDM 9.3X2.4	900824 EPDM 14X4	900825 EPDM 44.6X2.4				
	SEPTUM								
		900049 BUTYL							
MISC.									
		600065 CHAIN FOR MULTI MICRO PORT	900077 CHAIN	840055 FILM MULTI	840102 INNER PLATE FOR MICRO PORT	840118 TOOL MULTI	900054 NEEDLE	900055 WICK	
									
	900075 CLAMP RING 1/2"	900086 CLAMP RING 1"	900074 GASKET EPDM 3/4	900087 GASKET EPDM 1/2"	900091 GASKET EPDM 1"	900093 GASKET 3" CLAMP EPDM	INSERT FOR MICRO PORT	900102 900441 PLUG	

KEOFITT STEAM BOILER

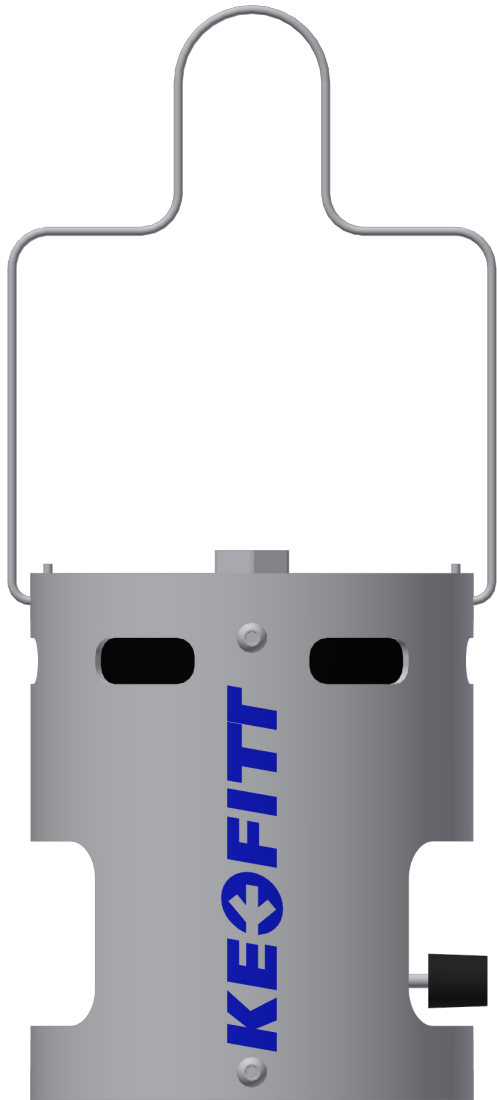

550000
STEAM BOILER

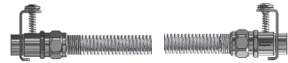

550002
PTFE TUING W/QC 0.5M



550003
PTFE TUING W/QC 1.0M



800830
O-RING SILICONE 10.3X2.4



150830
O-RING SILICONE 16X3



900031
HP W9/MALE THREAD M12



550242
BURNER STAND

KEOFITT CLIP-ON STEAMER

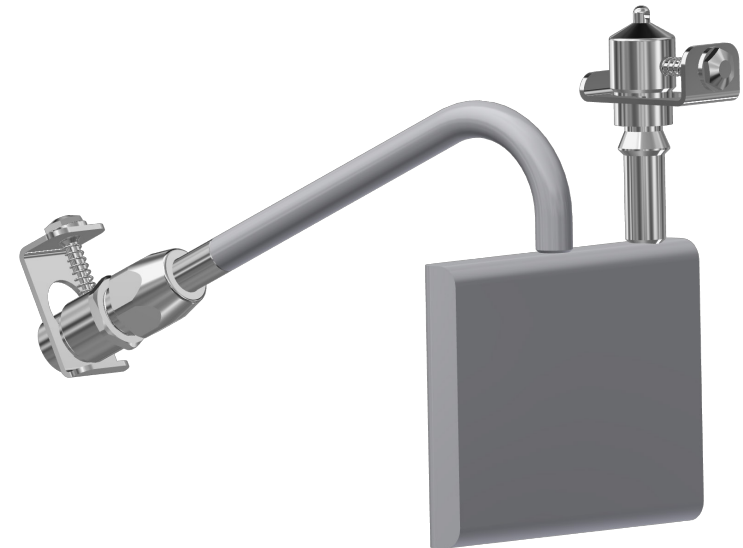

550009
CLIP-ON STEAMER

KEOFITT CARLSBERG FLASK



210001
CARLSBERG FLASK



550002
PTFE TUBING W/QC 0.5M



200210
FILTER FOR CARLSBERG
FLASK



550003
PTFE TUBING W/QC 1.0M



900031
HP W9/MALE THREAD M12



600051
MEMBRANE SILICONE W9



900049
MEMBRANE BUTYL

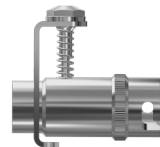

550057
KÄRCHER/KEOFITT
ADAPTOR

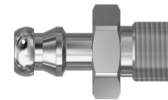

900037
HP M4/MALE THREAD M12



800830
O-RING SILICONE
10.3X2.4



900074
GASKET CLAMP 3/4"
EPDM

KEOFITT RECIRCULATOR



550010
RECIRCULATOR



550311
BULB PUMP

