





VALVE HEAD 4KAI TYPE Q EPDM



ART. NO. 440043E

GENERAL

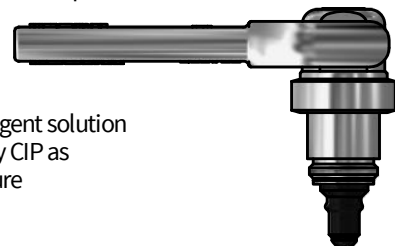
-  The KEOFITT 4KAI Sampling Valve is our low cost sterilizable sampling valve for less demanding applications. Replaces non-hygienic sampling cocks. More than 20 different configurations available.
-  The sampling valve can be used for any process sampling for chemical and/or physical analysis.
-  **Cleaning/sterilizing:** Between batches: Valve in open position: Cleanable by means of CIP using the detergent solution suitable for the actual process media. Between samples: Valve in its normal closed position: cleanable by CIP as "Between batches" or the valve may be sterilized by means of steam SIP or chemical SIP using a procedure appropriate to the actual circumstances. For further advice, please contact Keofitt. Autoclavable.
-  Designed for sampling of liquids with a viscosity of up to approx. 100 cP containing no particles larger than Ø1.5 mm. Sampling of more viscous liquids is possible, only will it take longer (depending on process pressure).



FEATURES

-  Installation: Threaded socket connection M18x1.5
-  Operation: Lever handle (#600170)
-  Membrane: EPDM (#400052)

CERTIFICATION*

- EU EC 1935/2004 · EU EC 2023/2006 · DK No. 1248 10/2018 · 3-A Certificate · ATEX 2014/34/EU
- PED 2014/68/EU · FDA CFR 21 §177.2600 · USP Class VI · Keofitt DoC

TECHNICAL DATA

Material (process contact)

- Membrane EPDM, BLACK (#400052)

Material (without process contact)

- Steel parts AISI 304 (1.4307)
- Lever handle AISI 316L (1.4404)

Membrane

- Article EPDM, BLACK (#400052)
- Certification*
 - EU EC 1935/2004 · EU EC 2023/2006
 - DK No. 1248 10/2018 · FDA CFR 21 §177.2600 · USP Class VI
 - REACH · RoHS · ADI Free · Keofitt DoC

Pressure & Temperature

- Pressure 0 - 6 bar / 0 - 87 psi
- Temperature 1 - 130°C / 34 - 266°F
- Air supply -

Net Weight

- kg/lbs 0.205 kg/0.451 lbs

Spareparts

- 400052 10 PACK MEMBRANE EPDM 4KAI/BASIX/M4
- 440149 BUSHING FOR 4KAI/BASIX HEAD

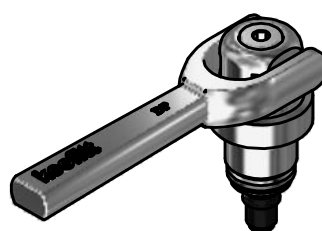
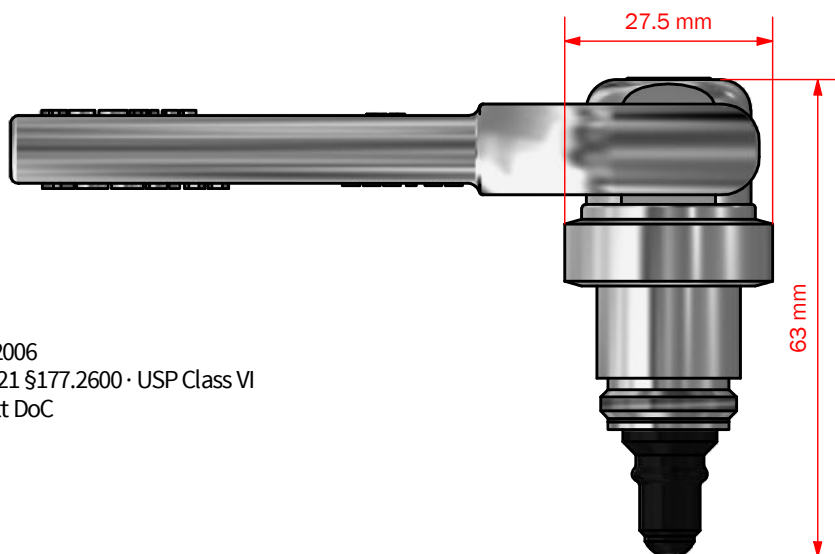

*For further information and download please visit www.keofitt.dk