





VALVE HEAD W9 TYPE H

ART. NO. 600041

GENERAL

-  The KEOFIT CLASSIC W9 Sampling Valve is the original and leading sterilizable sampling valve in the world. Used in all industries for decades. More than 320 standard valve configurations. Unique serial no. for each valve*.
-  The sampling valve can be used for any process sampling for microbiological, chemical and/or physical analysis.
-  **Cleaning/sterilizing:** Between batches: Valve in open position: Cleanable by means of CIP using the detergent solution suitable for the actual process media. Between samples: Valve in its normal closed position: cleanable by CIP as "Between batches" or the valve may be sterilized by means of steam SIP or chemical SIP using a procedure appropriate to the actual circumstances. For further advice, please contact Keofitt.
Not recommended for autoclave due to plastic parts.
-  Designed for sampling of liquids with a viscosity of up to approx. 1.000 cP containing no particles larger than Ø3 mm. Sampling of more viscous liquids is possible, only will it take longer (depending on process pressure).

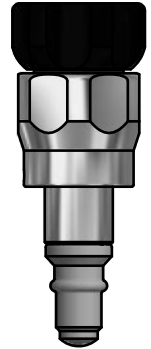

FEATURES

-  Installation: Threaded socket connection M22x1.5
-  Operation: Turn knob - spring loaded (opens clockwise)
-  Membrane: Silicone (#600051)

CERTIFICATION*

- EU EC 1935/2004 · EU EC 2023/2006 · DK No. 1248 10/2018 · 3-A Certificate · ATEX 2014/34/EU
- PED 2014/68/EU · FDA CFR 21 §177.2600 · USP Class VI · Keofitt DoC

TECHNICAL DATA

Material (process contact)

- Membrane SILICONE, GREY (#600051)

Material (without process contact)

- Steel parts AISI 303 (1.4305) / AISI 316L (1.4404)
- Knob PA6 (Black)

Membrane

- Article SILICONE, GREY (#600051)
- Certification* · EU EC 1935/2004 · EU EC 2023/2006 · DK No. 1248 10/2018 · FDA CFR 21 §177.2600 · USP Class VI · REACH · RoHS · ADI Free · Keofitt DoC

Pressure & Temperature

- Pressure 0 - 10 bar / 0 - 145 psi
- Temperature 1 - 130°C / 34 - 266°F
- Air supply -

Net Weight

- kg/lbs 0.228 kg/0.501 lbs





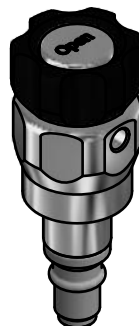
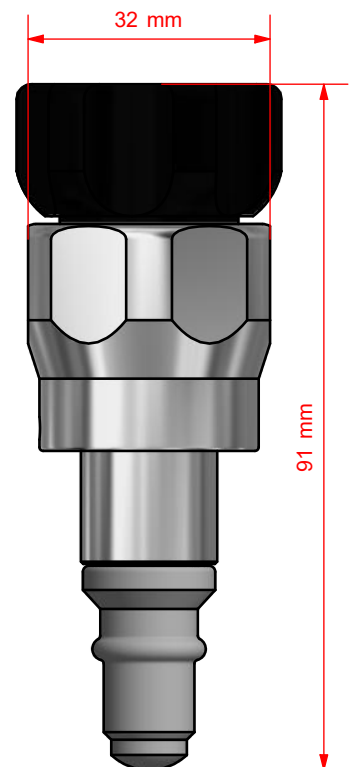





















Spareparts

- 776041 PARTS FOR W9 HEAD 600041/42/43/47















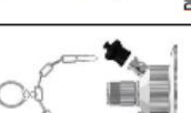









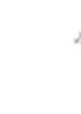





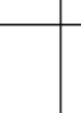











*For further information and download please visit www.keofitt.dk

KEOFITT CLASSIC W9 SAMPLING VALVE - BODIES

W9 BODIES		WELDING BODIES								
		TANK WELDING Ø28	PIPE WELDING 1"	PIPE WELDING NW25	IN-LINE VERTICAL	IN-LINE HORIZONTAL				
HOSE PIECE		850001		850011		850014		850027*		850028*
1/2" TRI-CLAMP		850006		850010						850020
THREAD M16X1,5		850015		850016						850024
1/2" WELDING ENDS		850007		850019						850026

* ON REQUEST ONLY!

CONNECTION BODIES						TREAD
VARIANT Ø50	VARIANT Ø68	MINI CLAMP	CLAMP 1" & 1½"	CLAMP 2"	CLAMP 3"	
						M28X1,5 850031 DIN 11851 DN 10 850040
						850008
						850013
						850039
						850022 850005
						850025 850026
						850037 M28X1,5

