





# VALVE HEAD W9 TYPE N

ART. NO. 600044

## GENERAL

-  The KEOFIT CLASSIC W9 Sampling Valve is the original and leading sterilizable sampling valve in the world. Used in all industries for decades. More than 320 standard valve configurations. Unique serial no. for each valve\*.
-  The sampling valve can be used for any process sampling for microbiological, chemical and/or physical analysis.
-  **Cleaning/sterilizing:** Between batches: Valve in open position: Cleanable by means of CIP using the detergent solution suitable for the actual process media. Between samples: Valve in its normal closed position: cleanable by CIP as "Between batches" or the valve may be sterilized by means of steam SIP or chemical SIP using a procedure appropriate to the actual circumstances. For further advice, please contact Keofitt. Autoclavable.
-  Designed for sampling of liquids with a viscosity of up to approx. 1.000 cP containing no particles larger than Ø3 mm. Sampling of more viscous liquids is possible, only will it take longer (depending on process pressure).

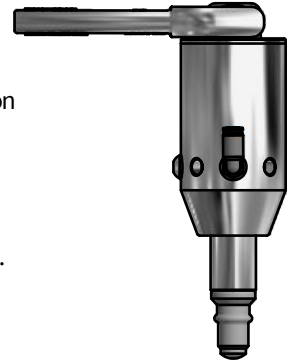

## FEATURES

-  Installation: Threaded socket connection M22x1.5
-  Operation: Pneumatically operated / Lever handle (#600170)
-  Membrane: Silicone (#600051)

## CERTIFICATION\*

- EU EC 1935/2004 · EU EC 2023/2006 · DK No. 1248 10/2018 · 3-A Certificate · ATEX 2014/34/EU
- PED 2014/68/EU · FDA CFR 21 §177.2600 · USP Class VI · Keofitt DoC

## TECHNICAL DATA

### Material (process contact)

- Membrane SILICONE, GREY (#600051)

### Material (without process contact)

- Steel parts AISI 303 (1.4305) / AISI 316L (1.4404)
- Lever handle AISI 316L (1.4404)

### Membrane

- Article SILICONE, GREY (#600051)
- Certification\* · EU EC 1935/2004 · EU EC 2023/2006 · DK No. 1248 10/2018 · FDA CFR 21 §177.2600 · USP Class VI · REACH · RoHS · ADI Free · Keofitt DoC

### Pressure & Temperature

- Pressure 0 - 10 bar / 0 - 145 psi
- Temperature 1 - 130°C / 34 - 266°F
- Air supply 4 - 7 bar / 58 - 101 psi

### Net Weight

- kg/lbs 0.834 kg/1.837 lbs





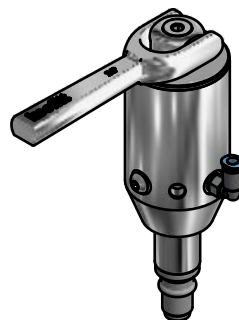
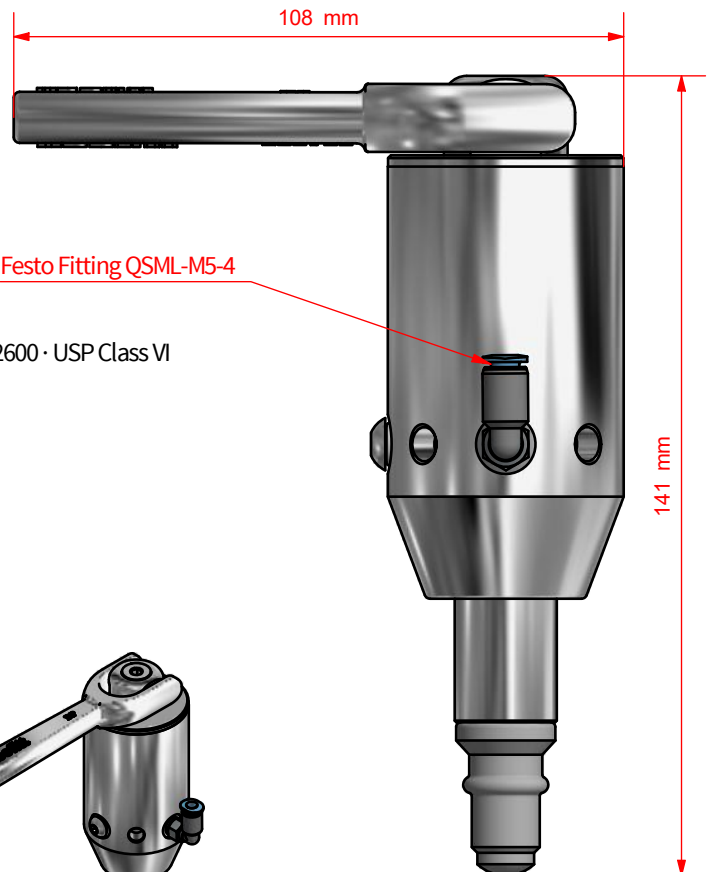

















### Spareparts

- 776044 PARTS FOR W9 HEAD 600044/45













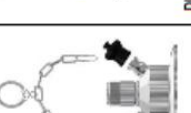

\*For further information and download please visit [www.keofitt.dk](http://www.keofitt.dk)

# KEOFITT CLASSIC W9 SAMPLING VALVE - BODIES

W9 BODIES		WELDING BODIES							
		TANK WELDING Ø28	PIPE WELDING 1"	PIPE WELDING NW25	IN-LINE VERTICAL	IN-LINE HORIZONTAL			
HOSE PIECE		850001		850011			850027*		850028*
1/2" TRI-CLAMP		850006		850010					850020
THREAD M16X1,5		850015		850016					850013
1/2" WELDING ENDS		850007		850019					850039

\* ON REQUEST ONLY!

CONNECTION BODIES						TREAD
VARIANT Ø50	VARIANT Ø68	MINI CLAMP	CLAMP 1" & 1½"	CLAMP 2"	CLAMP 3"	
						M28X1,5 850031 DIN 11851 DN 10 850040
						850037 M28X1,5

