





VALVE HEAD W9 TYPE Q PTFE



ART. NO. 855543

GENERAL

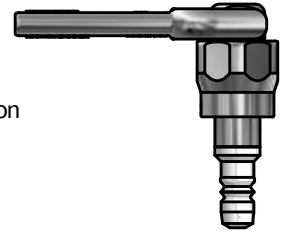
-  The KEOFIT CLASSIC W9 Sampling Valve is the original and leading sterilizable sampling valve in the world. Used in all industries for decades. More than 320 standard valve configurations. Unique serial no. for each valve*.
-  The sampling valve can be used for any process sampling for microbiological, chemical and/or physical analysis.
-  **Cleaning/sterilizing:** Between batches: Valve in open position: Cleanable by means of CIP using the detergent solution suitable for the actual process media. Between samples: Valve in its normal closed position: cleanable by CIP as "Between batches" or the valve may be sterilized by means of steam SIP or chemical SIP using a procedure appropriate to the actual circumstances. For further advice, please contact Keofitt. Autoclavable.
-  Designed for sampling of liquids with a viscosity of up to approx. 1.000 cP containing no particles larger than Ø3 mm. Sampling of more viscous liquids is possible, only will it take longer (depending on process pressure).



FEATURES

-  Installation: Threaded socket connection M22x1.5
-  Operation: Lever handle (#600170)
-  Membrane: PTFE (#850055)

CERTIFICATION*

- EU EC 1935/2004 · EU EC 2023/2006 · EU EC 10/2011 · DK No. 1248 10/2018 · ATEX 2014/34/EU
- PED 2014/68/EU · FDA CFR 21 §177.1550 · USP Class VI · Keofitt DoC

TECHNICAL DATA

Material (process contact)

- Membrane PTFE, WHITE (#850055)

Material (without process contact)

- Steel parts AISI 303 (1.4305) / AISI 316L (1.4404)
- Lever handle AISI 316L (1.4404)

Membrane

- Article PTFE, WHITE (#850055)
- Certification*
 - EU EC 1935/2004 · EU EC 2023/2006 · EU EC 10/2011
 - DK No. 1248 10/2018 · FDA CFR 21 §177.1550 · USP Class VI
 - ADI Free · Keofitt DoC

Pressure & Temperature

- Pressure 0 - 10 bar / 0 - 145 psi
- Temperature 1 - 150°C / 34 - 302°F
- Air supply -

Net Weight

- kg/lbs 0.309 kg/0.68 lbs





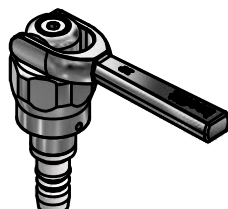
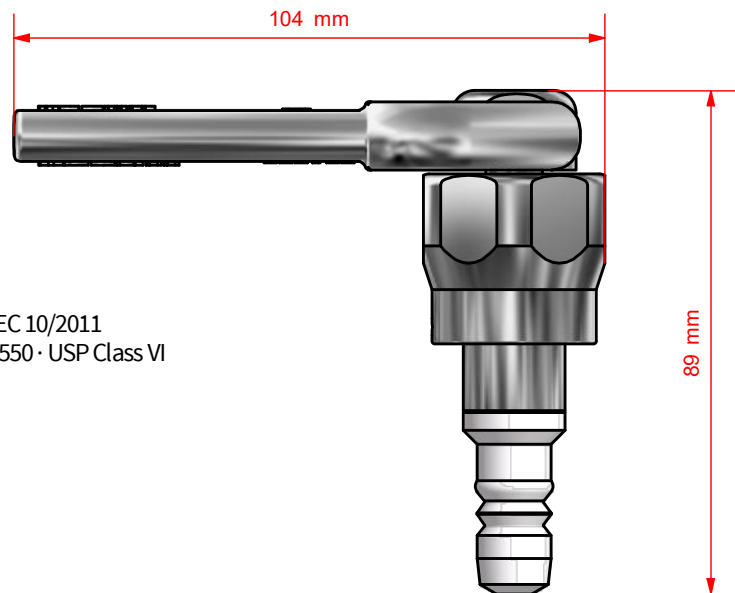















Spareparts

- 778541 PARTS FOR W9 HEAD 855541/42/43/47

















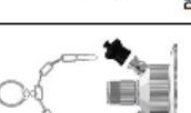





*For further information and download please visit www.keofitt.dk

KEOFITT CLASSIC W9 SAMPLING VALVE - BODIES

W9 BODIES	WELDING BODIES				
	TANK WELDING Ø28	PIPE WELDING 1"	PIPE WELDING NW25	IN-LINE VERTICAL	IN-LINE HORIZONTAL
HOSE PIECE	 850001	 850011	 850014	 850027*	 850028*
1/2" TRI-CLAMP	 850006	 850010	 850018	 On request	 On request
THREAD M16X1,5	 850015	 850016	 850018	 On request	 On request
1/2" WELDING ENDS	 850007	 850019	 On request	 On request	 On request

* ON REQUEST ONLY!



CONNECTION BODIES	CLAMP						TREAD
	VARIANT Ø50	VARIANT Ø68	MINI CLAMP	CLAMP 1" & 1 1/2"	CLAMP 2"	CLAMP 3"	
	 850008	 850009	 850036	 850021	 850003	 850004	 M28X1,5 850031 DIN 11851 DN 10 850040
	 850020	 850013	 850039	 850022 850025	 850005 850026	 On request	 850037 M28X1,5
	 On request	 On request	 On request	 850024	 On request	 On request	

