

SAMPLING BOTTLE HEAD FOR W25

ART. NO. 870030

GENERAL

- The KEOFITT SAMPLING BOTTLE HEAD enables the user to collect and transport a truly representative sterile sample. The system protects the sample against airborne contamination during sampling and transport.
- The sampling bottle head can be used for any process sampling for chemical and/or physical analysis.
- The sampling bottle head must be disassembled, cleaned, autoclaved and reassembled before each use. It is designed to be steam sterilized once connected to the sampling valve. In this way one can assure a sterile flow path and the retrieval of a sterile sample. For further advice, please contact Keofitt.
- The sampling bottle head is autoclavable and designed to be used with PP bottles:
#260325 (250 ml) - #260525 (1000 ml) - #260625 (2000 ml).
Bottle is not included and must be ordered separately.



FEATURES

- Connection: To KEOFITT sampling valve W25 by using a PTFE tubing w/clamp
- Inlet / Air-outlet: Hose piece

CERTIFICATION*

· EU EC 1935/2004 · EU EC 2023/2006 · DK No. 1248 10/2018 · 3.1 Material Certificate · Ra Certificate

TECHNICAL DATA

Material (process contact)

Material (without process contact)

- Steel parts AISI 316L (1.4404)
- Closure Polypropylene
- Sealing ring Thermoplastic elastomer (TPE)

Surface Treatment

- Outside Electropolished Ra ≤ 1.2 µm
- Inside (wetted surface) Electropolished Ra ≤ 0.5 µm

Pressure & Temperature

- Pressure Recommended for pressure-less flow obtained by gravity.
- Temperature Depending on choice of bottle.

Net Weight

- kg/lbs 0.327 kg/0.72 lbs

Spareparts

- 260326 CLOSURE w/O f/PP BOTTLE 250/1000/2000 ml
- 260327 10 PACK GASKET f/CLOSURE f/PP BOTTLE 250/1000/2000 ml

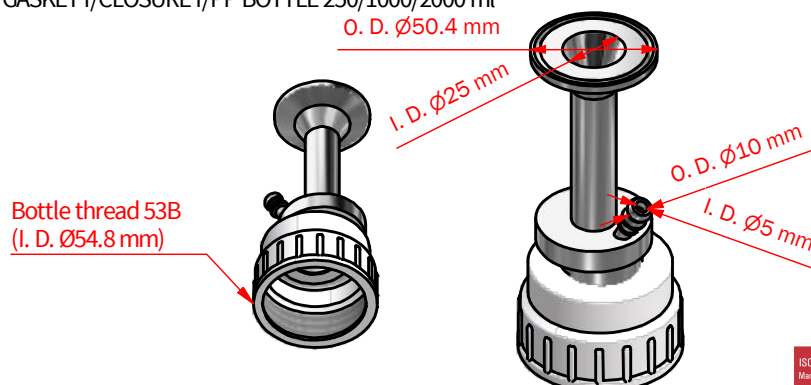
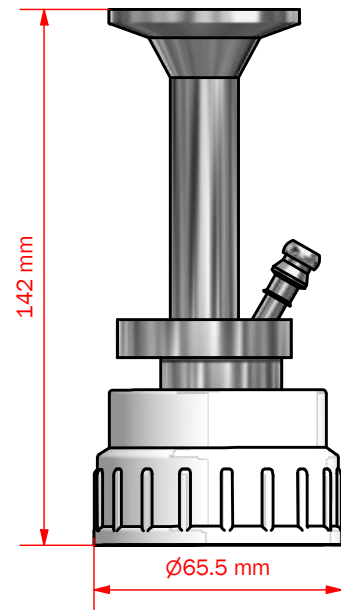

*For further information and download please visit www.keofitt.dk

KEOFITT A/S reserves the right to change technical data without notice! Valid version of the data sheets is available on www.keofitt.dk.