





# SESAME HEAD TYPE H EPDM



ART. NO. 890041E

## GENERAL

-  The KEOFITT SESAME Sampling Valve is our patented dual-seat sampling valve. Unique in the market, it eliminates dead-leg during sampling while incorporating steam supply control. Unique serial no. for each valve\*.
-  The sampling valve can be used for any process sampling for microbiological, chemical and/or physical analysis.
-  **Cleaning/sterilizing:** Between batches: Valve in open position: Cleanable by means of CIP using the detergent solution suitable for the actual process media. Between samples: Valve in its normal closed position: cleanable by CIP as "Between batches" or the valve may be sterilized by means of steam SIP or chemical SIP using a procedure appropriate to the actual circumstances. For further advice, please contact Keofitt. Not recommended for autoclave due to plastic parts.
-  Designed for sampling of liquids with a viscosity of up to approx. 1.000 cP containing no particles larger than Ø3 mm. Sampling of more viscous liquids is possible, only will it take longer (depending on process pressure).



## FEATURES

-  Installation: Clamp connection (clamp ring included, #900189)
-  Operation: Turn knob
-  Membrane: EPDM (#890052)

## CERTIFICATION\*

- EU EC 1935/2004 · EU EC 2023/2006 · DK No. 1248 10/2018 · 3-A Certificate · ATEX 2014/34/EU
- PED 2014/68/EU · FDA CFR 21 §177.2600 · USP Class VI · Keofitt DoC

## TECHNICAL DATA

### Material (process contact)

- Membrane EPDM, BLACK (#890052)

### Material (without process contact)

- Steel parts AISI 316L (1.4404)
- Knob POM-C (polyacetal (Copolymer))

### Membrane

- Article EPDM, BLACK (#890052)
- Certification\*
  - EU EC 1935/2004 · EU EC 2023/2006
  - DK No. 1248 10/2018 · FDA CFR 21 §177.2600 · USP Class VI
  - REACH · RoHS · ADI Free · Keofitt DoC

### Pressure & Temperature

- Pressure 0 - 10 bar / 0 - 145 psi (Process & CIP/SIP)
- Temperature 1 - 130°C / 34 - 266°F
- Air supply -

### Net Weight

- kg/lbs 0.743 kg/1.636 lbs

### Spareparts

- 890052 10 PACK MEMBRANE EPDM SESAME

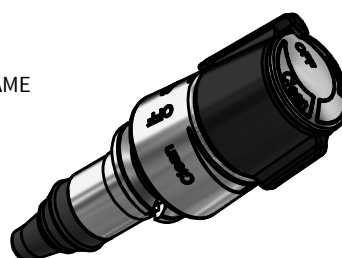
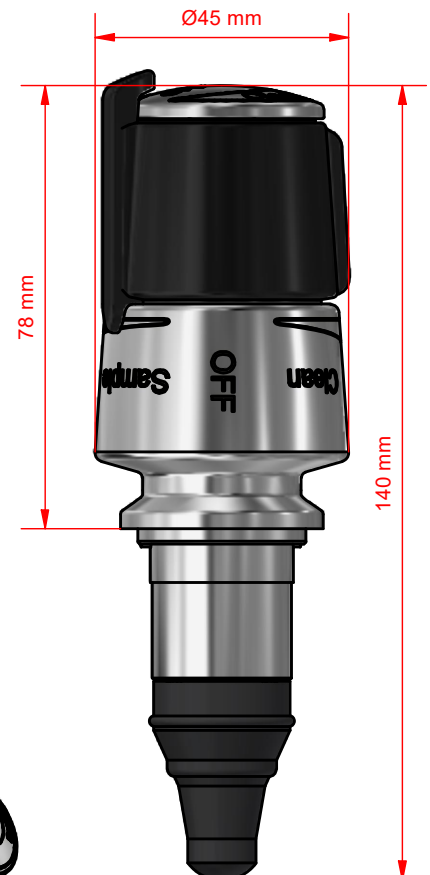

**"Patented: DK 175721 B1, CN 100501219C, EP 1 690 038 B1, US 7,658,201 B2"**

















\*For further information and download please visit [www.keofitt.dk](http://www.keofitt.dk)

KEOFITT A/S reserves the right to change technical data without notice! Valid version of the data sheets is available on [www.keofitt.dk](http://www.keofitt.dk).



Last updated 03-09-2021

# KEOFITT SESAME VALVE - BODIES

WELDING BODIES		CONNECTION BODIES				CONNECTION BODIES				INGOLD	
		Tank Welding	Pipe Welding	Variant Ø50	Variant Ø68	Mini Clamp	Clamp 1"	Clamp 2"	Thread	Union DIN 11851	Ingold 40 mm port length
Hose Piece	 890001	 890011	 890008	 890009	 890038	 NA-CONNECT ASME/DIN 890021	 890003	<i>On request</i>	 890040	 893105	 893205
	Mini Tri-Clamp	 890008	 890010	<i>On request</i>	<i>On request</i>	 890039	 NA-CONNECT ASME/DIN 890022	<i>On request</i>	<i>On request</i>	<i>On request</i>	 893105
Thread M1.6x1.5		<i>On request</i>	<i>On request</i>	<i>On request</i>	<i>On request</i>	<i>On request</i>	<i>On request</i>	<i>On request</i>	<i>On request</i>	<i>On request</i>	
	Welding Ends	 890007	 890018	<i>On request</i>	<i>On request</i>	<i>On request</i>	<i>On request</i>	<i>On request</i>	<i>On request</i>	<i>On request</i>	