





SESAME HEAD TYPE Q



ART. NO. 890043

GENERAL

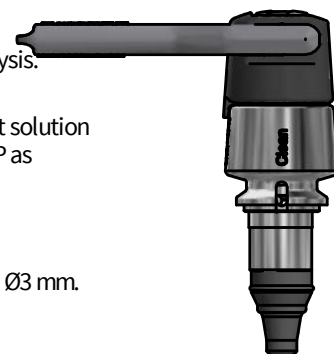
-  The KEOFITT SESAME Sampling Valve is our patented dual-seat sampling valve. Unique in the market, it eliminates dead-leg during sampling while incorporating steam supply control. Unique serial no. for each valve*.
-  The sampling valve can be used for any process sampling for microbiological, chemical and/or physical analysis.
-  **Cleaning/sterilizing:** Between batches: Valve in open position: Cleanable by means of CIP using the detergent solution suitable for the actual process media. Between samples: Valve in its normal closed position: cleanable by CIP as "Between batches" or the valve may be sterilized by means of steam SIP or chemical SIP using a procedure appropriate to the actual circumstances. For further advice, please contact Keofitt. Not recommended for autoclave due to plastic parts.
-  Designed for sampling of liquids with a viscosity of up to approx. 1.000 cP containing no particles larger than Ø3 mm. Sampling of more viscous liquids is possible, only will it take longer (depending on process pressure).



FEATURES

-  Installation: Clamp connection (clamp ring included, #900189)
-  Operation: Lever handle (#890170)
-  Membrane: Silicone (#890051)

CERTIFICATION*

- EU EC 1935/2004 · EU EC 2023/2006 · DK No. 1248 10/2018 · 3-A Certificate · ATEX 2014/34/EU
- PED 2014/68/EU · FDA CFR 21 §177.2600 · USP Class VI · Keofitt DoC

TECHNICAL DATA

Material (process contact)

- Membrane SILICONE, GREY (#890051)

Material (without process contact)

- Steel parts AISI 316L (1.4404)
- Knob PA6-3G-1L2 (Black)
- Lever handle AISI 316L (1.4404)

Membrane

- Article SILICONE, GREY (#890051)
- Certification*
 - EU EC 1935/2004 · EU EC 2023/2006
 - DK No. 1248 10/2018 · FDA CFR 21 §177.2600 · USP Class VI
 - REACH · RoHS · ADI Free · Keofitt DoC

Pressure & Temperature

- Pressure 0 - 10 bar / 0 - 145 psi (Process & CIP/SIP)
- Temperature 1 - 130°C / 34 - 266°F
- Air supply -

Net Weight

- kg/lbs 0.842 kg/1.854 lbs

Spareparts

- NOT APPLICABLE

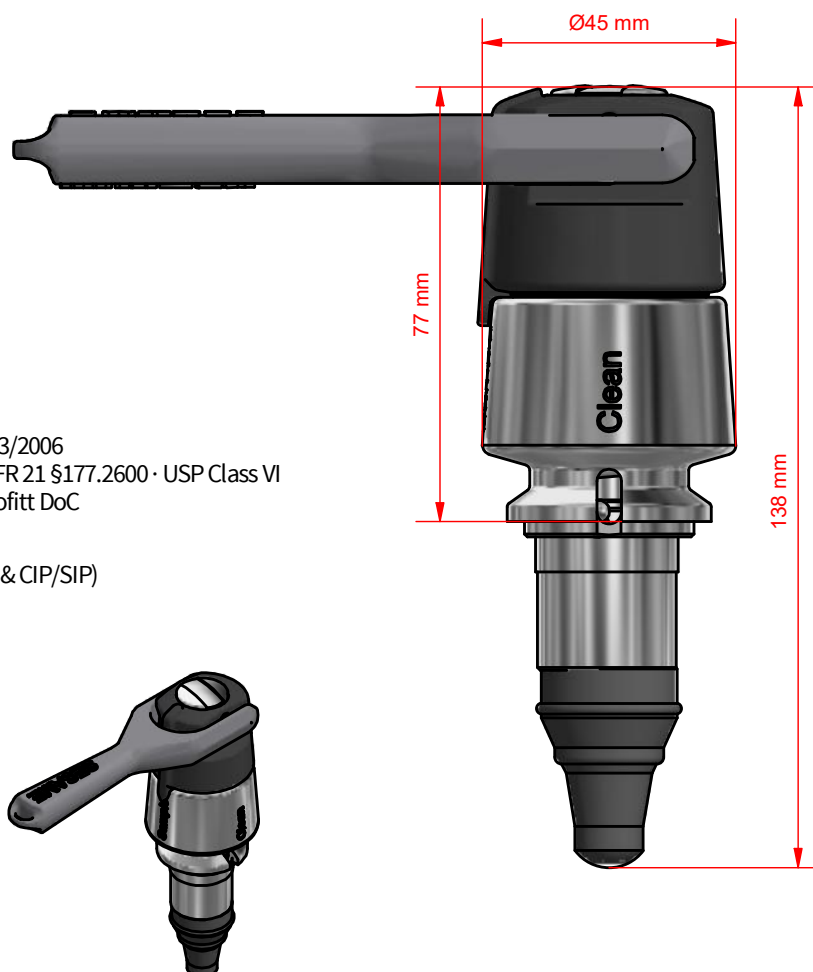





















"Patented: DK 175721 B1, CN 100501219C, EP 1 690 038 B1, US 7,658,201 B2"

*For further information and download please visit www.keofitt.dk

KEOFITT A/S reserves the right to change technical data without notice! Valid version of the data sheets is available on www.keofitt.dk.

KEOFITT SESAME VALVE - BODIES

| WELDING BODIES | | CONNECTION BODIES | | | | | CONNECTION BODIES | | | | INGOLD | |
|----------------|--------|---|---|---|---|---|--|---|---|---|---|--|
| | | Tank Welding | Pipe Welding | Variant Ø50 | Variant Ø68 | Mini Clamp | Clamp 1" | Clamp 2" | Thread | Union DIN 11851 | Ingold 40 mm port length | Ingold 50 mm port length |
| Hose Piece | 890001 |  |  |  |  |  |  |  |  |  | | |
| | 890008 |  |  |  |  |  |  |  |  |  |  |  |
| Thread M16x1,5 | 890015 | On request | On request | On request | On request | On request | On request | On request | On request | On request | On request | |
| | 890018 | On request | On request | On request | On request | On request | On request | On request | On request | On request | On request | |
| Welding Ends | 890007 |  | On request | On request | On request | On request | On request | On request | On request | On request | On request | |
| | 890019 | On request | On request | On request | On request | On request | On request | On request | On request | On request | On request | |