





SESAME HEAD TYPE Q EPDM



ART. NO. 890043E

GENERAL

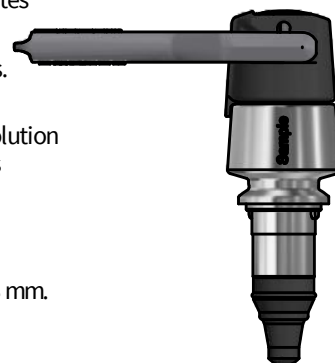
-  The KEOFITT SESAME Sampling Valve is our patented dual-seat sampling valve. Unique in the market, it eliminates dead-leg during sampling while incorporating steam supply control. Unique serial no. for each valve*.
-  The sampling valve can be used for any process sampling for microbiological, chemical and/or physical analysis.
-  **Cleaning/sterilizing:** Between batches: Valve in open position: Cleanable by means of CIP using the detergent solution suitable for the actual process media. Between samples: Valve in its normal closed position: cleanable by CIP as "Between batches" or the valve may be sterilized by means of steam SIP or chemical SIP using a procedure appropriate to the actual circumstances. For further advice, please contact Keofitt. Not recommended for autoclave due to plastic parts.
-  Designed for sampling of liquids with a viscosity of up to approx. 1.000 cP containing no particles larger than Ø3 mm. Sampling of more viscous liquids is possible, only will it take longer (depending on process pressure).



FEATURES

-  Installation: Clamp connection (clamp ring included, #900189)
-  Operation: Lever handle (#890170)
-  Membrane: EPDM (#890052)

CERTIFICATION*

- EU EC 1935/2004 · EU EC 2023/2006 · DK No. 1248 10/2018 · 3-A Certificate · ATEX 2014/34/EU
- PED 2014/68/EU · FDA CFR 21 §177.2600 · USP Class VI · Keofitt DoC

TECHNICAL DATA

Material (process contact)

- Membrane EPDM, BLACK (#890052)

Material (without process contact)

- Steel parts AISI 316L (1.4404)
- Knob PA6-3G-1L2 (Black)
- Lever handle AISI 316L (1.4404)

Membrane

- Article EPDM, BLACK (#890052)
- Certification*
 - EU EC 1935/2004 · EU EC 2023/2006
 - DK No. 1248 10/2018 · FDA CFR 21 §177.2600 · USP Class VI
 - REACH · RoHS · ADI Free · Keofitt DoC

Pressure & Temperature

- Pressure 0 - 10 bar / 0 - 145 psi (Process & CIP/SIP)
- Temperature 1 - 130°C / 34 - 266°F
- Air supply -

Net Weight

- kg/lbs 0.84 kg/1.851 lbs

Spareparts

- NOT APPLICABLE

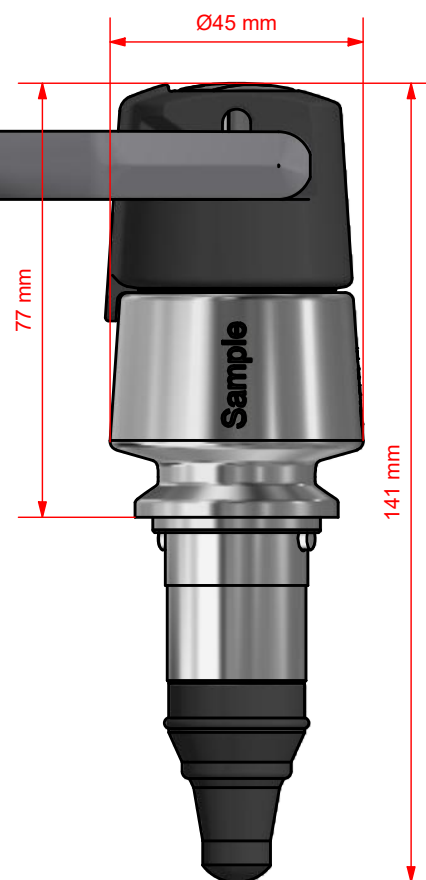
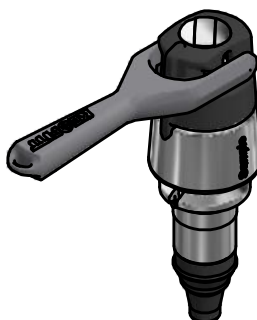

"Patented: DK 175721 B1, CN 100501219C, EP 1 690 038 B1, US 7,658,201 B2"





















*For further information and download please visit www.keofitt.dk

KEOFITT A/S reserves the right to change technical data without notice! Valid version of the data sheets is available on www.keofitt.dk.



Last updated 16-05-2020

KEOFITT SESAME VALVE - BODIES

WELDING BODIES		CONNECTION BODIES				CONNECTION BODIES				INGOLD		
		Tank Welding	Pipe Welding	Variant Ø50	Variant Ø68	Mini Clamp	Clamp 1"	Clamp 2"	Thread	Union DIN 11851	Ingold 40 mm port length	Ingold 50 mm port length
Hose Piece	890001											
	890008											
Thread M16x1,5	890015	On request	On request	On request	On request	On request	On request	On request	On request	On request		
	890018	On request	On request	On request	On request	On request	On request	On request	On request	On request		
Welding Ends	890007		On request	On request	On request	On request	On request	On request	On request	On request		
	890019	On request	On request	On request	On request	On request	On request	On request	On request	On request		