





# MICRO PORT TYPE MINI TRI-CLAMP



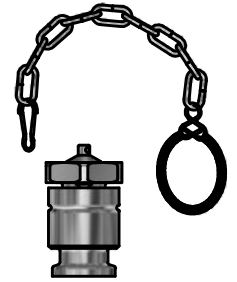

ART. NO. 900059

## GENERAL

-  The KEOFITT MICRO PORT is a re-sealing rubber septum designed to take samples using hypodermic needles or syringes with minimal risk of cross-contamination. Designed for sampling low viscosity products. Unique serial no. for each Micro Port\*.
-  The MICRO PORT can be used for any process sampling for microbiological, chemical and/or physical analysis.
-  Designed for sampling of liquids with a viscosity of up to approx. 50 cP containing no particles larger than Ø0.8 mm.
-  Please note that the sealing capacity is reduced with piercing.



## FEATURES

-  Installation: Mini Tri-Clamp DIN 32676:2009-05 Table 4 Row C
-  Operation: Manually operated
-  Recommended to be used with hypodermic needle (#900054).
-  Septum: Butyl IIR (#900049)

## CERTIFICATION\*

- EU EC 1935/2004 · EU EC 2023/2006 · DK No. 1248 10/2018 · 3.1 Material Certificate · Ra Certificate · PED 2014/68/EU
- FDA CFR 21 §177.2600 · USP Class VI · ADI Free · Keofitt DoC

## TECHNICAL DATA

### Material (process contact)

- Steel parts                   AISI 316L (1.4404)
- Septum                        Butyl IIR (LIGHT GREY/WHITE, #900049)

### Material (without process contact)

- Steel parts                   AISI 316L (1.4404)
- O-ring                        EPDM, BLACK (#900825)
- Stainless steel chain       AISI 316L (1.4404)

### Septum

- Article                        Butyl IIR (LIGHT GREY/WHITE, #900049)
- Certification\*               · EU EC 1935/2004 · EU EC 2023/2006 · DK No. 1248 10/2018
- FDA CFR 21 §177.2600 · USP Class VI · ADI Free · Keofitt DoC

### Surface Treatment

- Outside                      Electropolished Ra ≤ 1.2 µm
- Inside (wetted surface)   Electropolished Ra ≤ 0.5 µm
- Process connection       Electropolished Ra ≤ 0.5 µm

### Pressure & Temperature

- Pressure                     0 - 10 bar / 0 - 145 psi
- Temperature                1 - 110°C / 34 - 230° F
- Air supply                   -

### Net Weight

- kg/lbs                        0.186 kg/0.41 lbs

### Spareparts

- 779056                        PARTS MICROPORT 900014/56/57/58/59

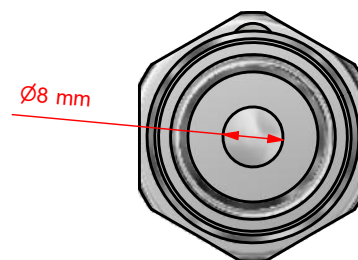
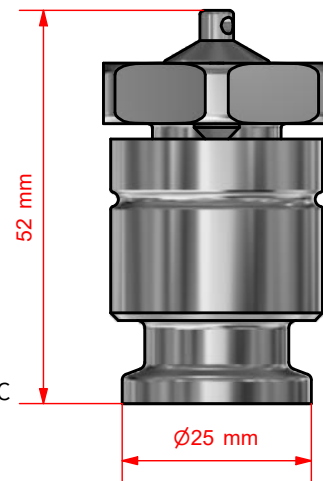

\*For further information and download please visit [www.keofitt.dk](http://www.keofitt.dk)

